

BETOGEHTER SIT TOGHTER DREAM TOGHTER  
FUN TOGHTER BUILD TOGHTER

# Roaming Park LA | TeckPack

Xinyi Ren

Capstone Project

SU 2021 | 2021.8.20

Instructor: Babette Strousse, Jonathan Abarbanel

IN PROGRESS PARK IN PROGRESS PARK IN PROGRESS PARK IN PROGRESS

IN PROGRESS PARK IN PROGRESS PARK

PARK IN PROGRESS PARK IN PROGRESS

ROAMING  
PARK L.A.

PARK IN PROGRESS PARK IN PROGRESS PARK IN PROGRESS PARK IN PROGRESS



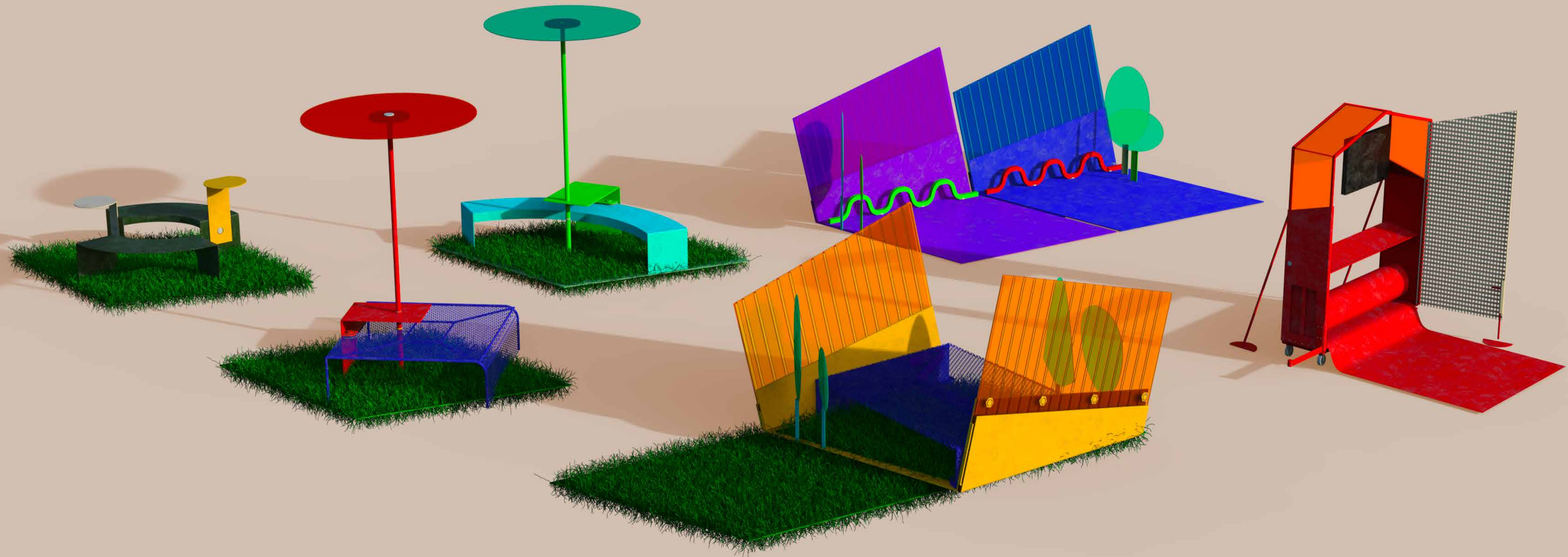



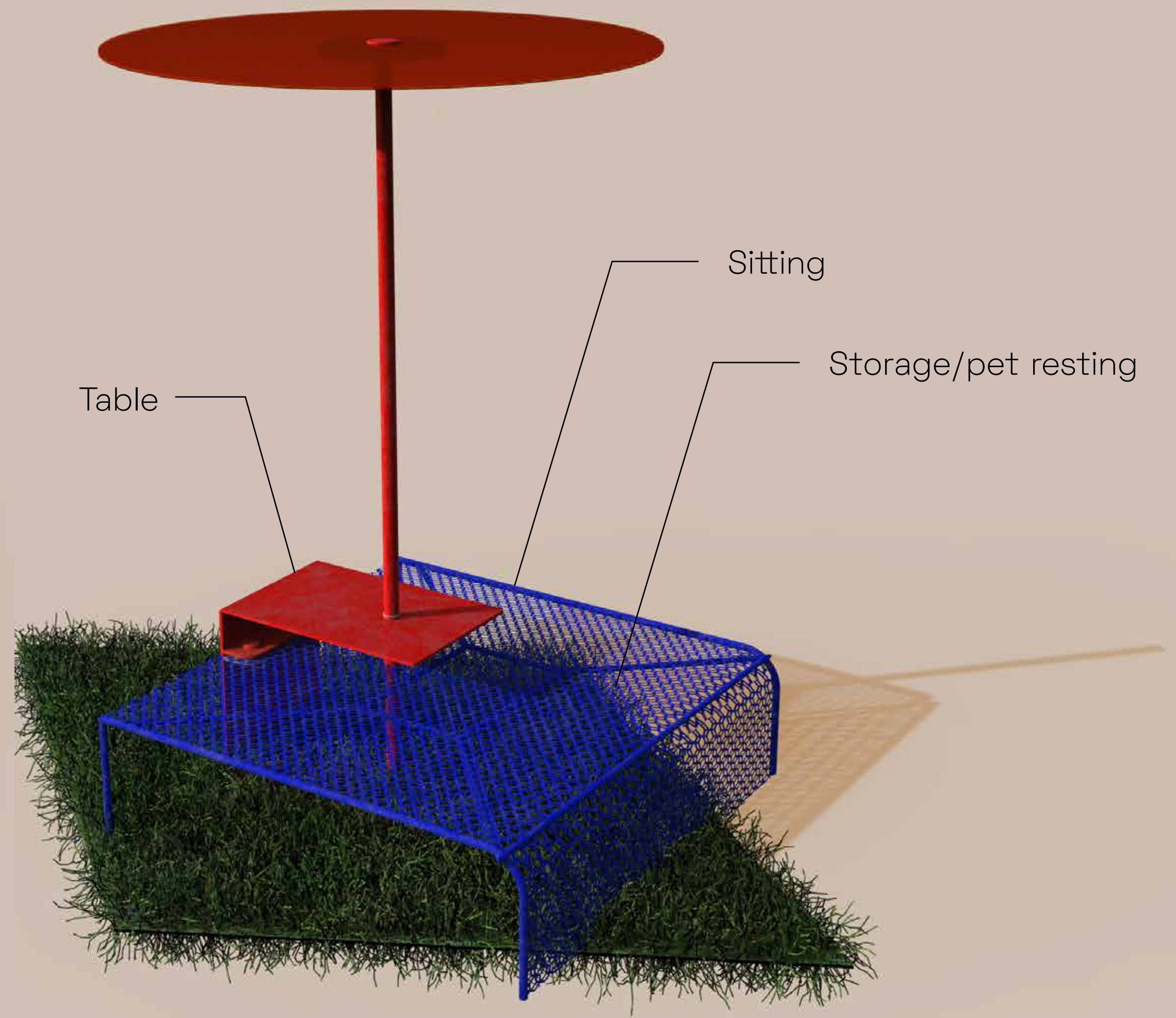
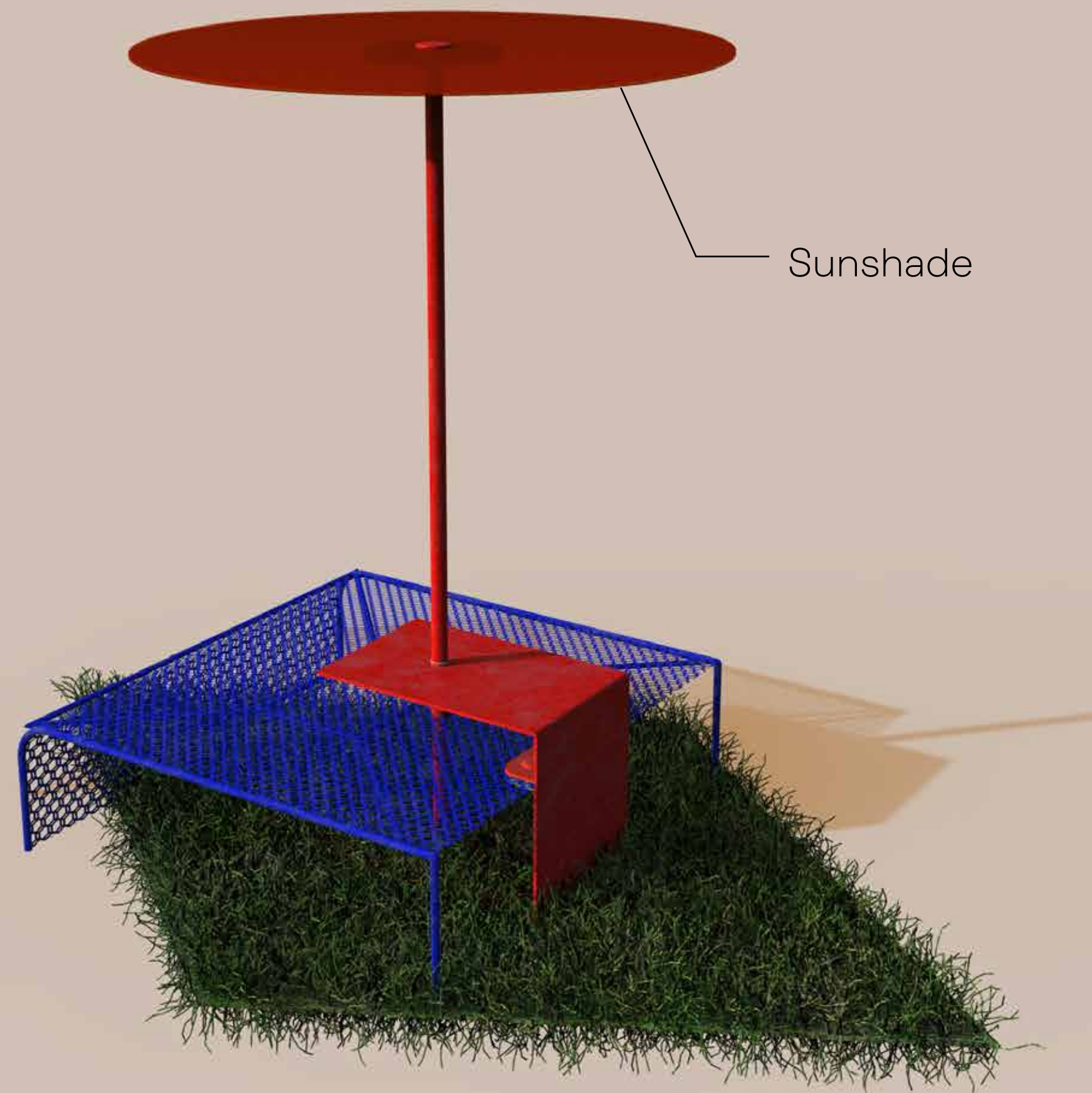



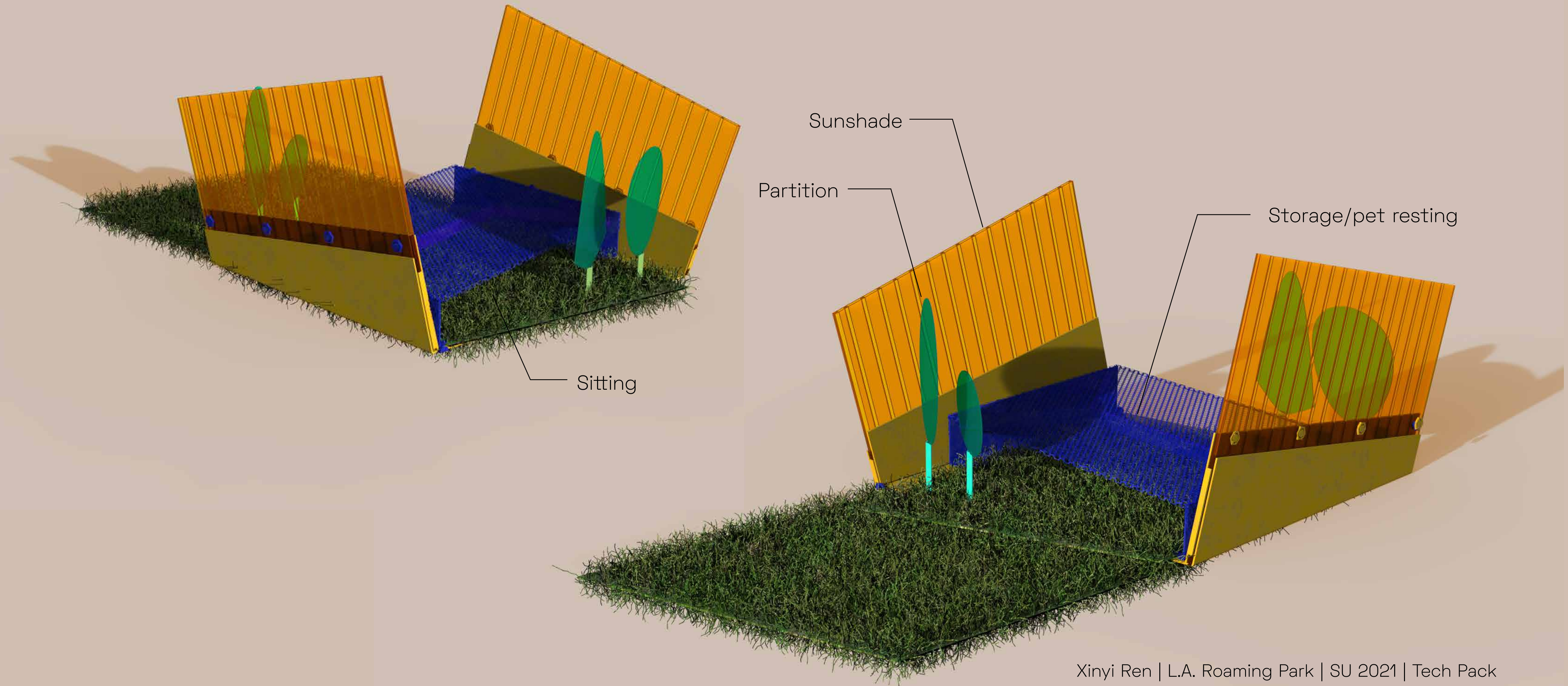



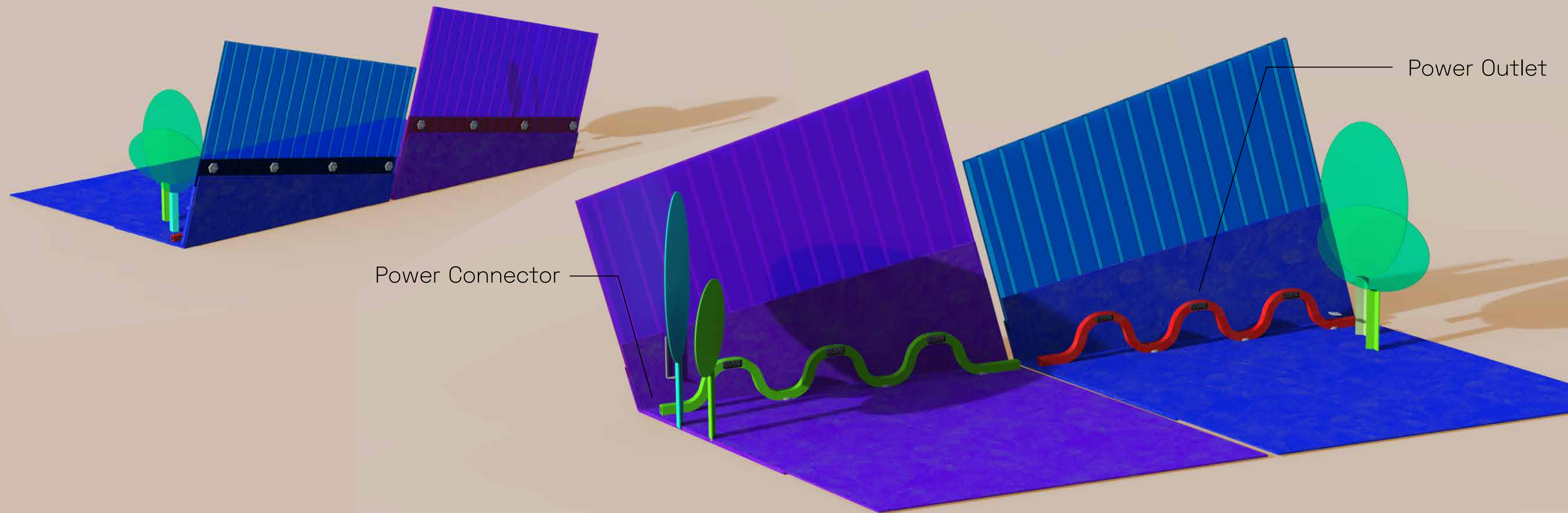



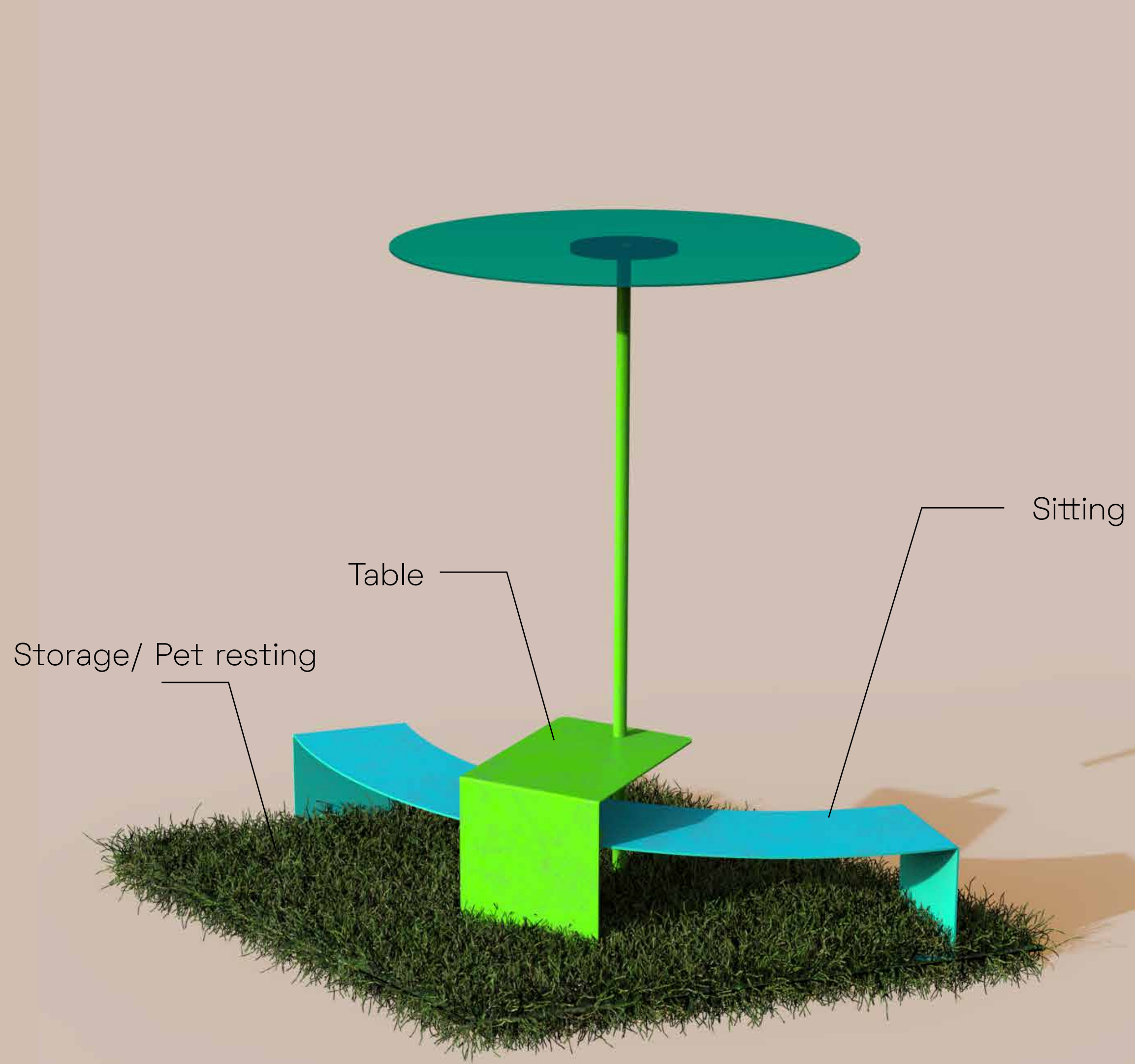



Table

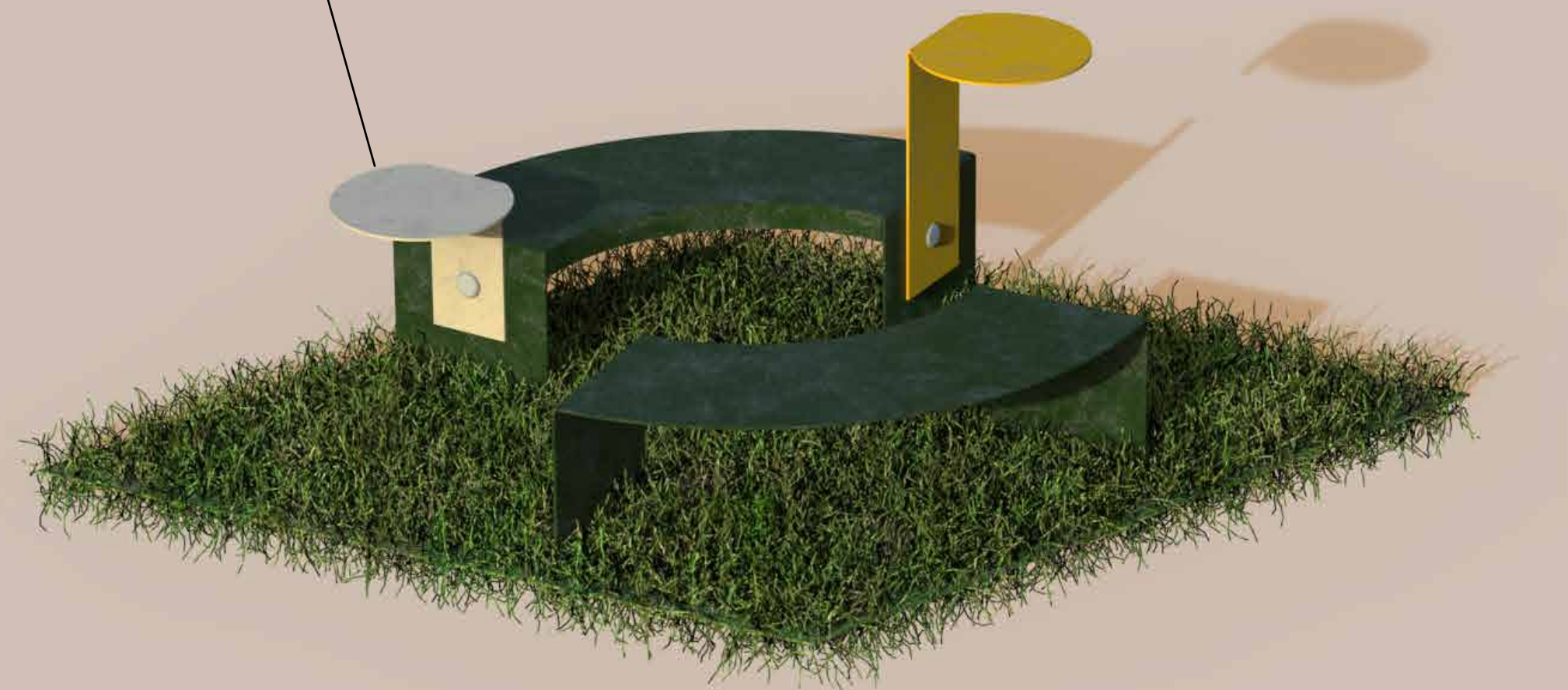

Sitting

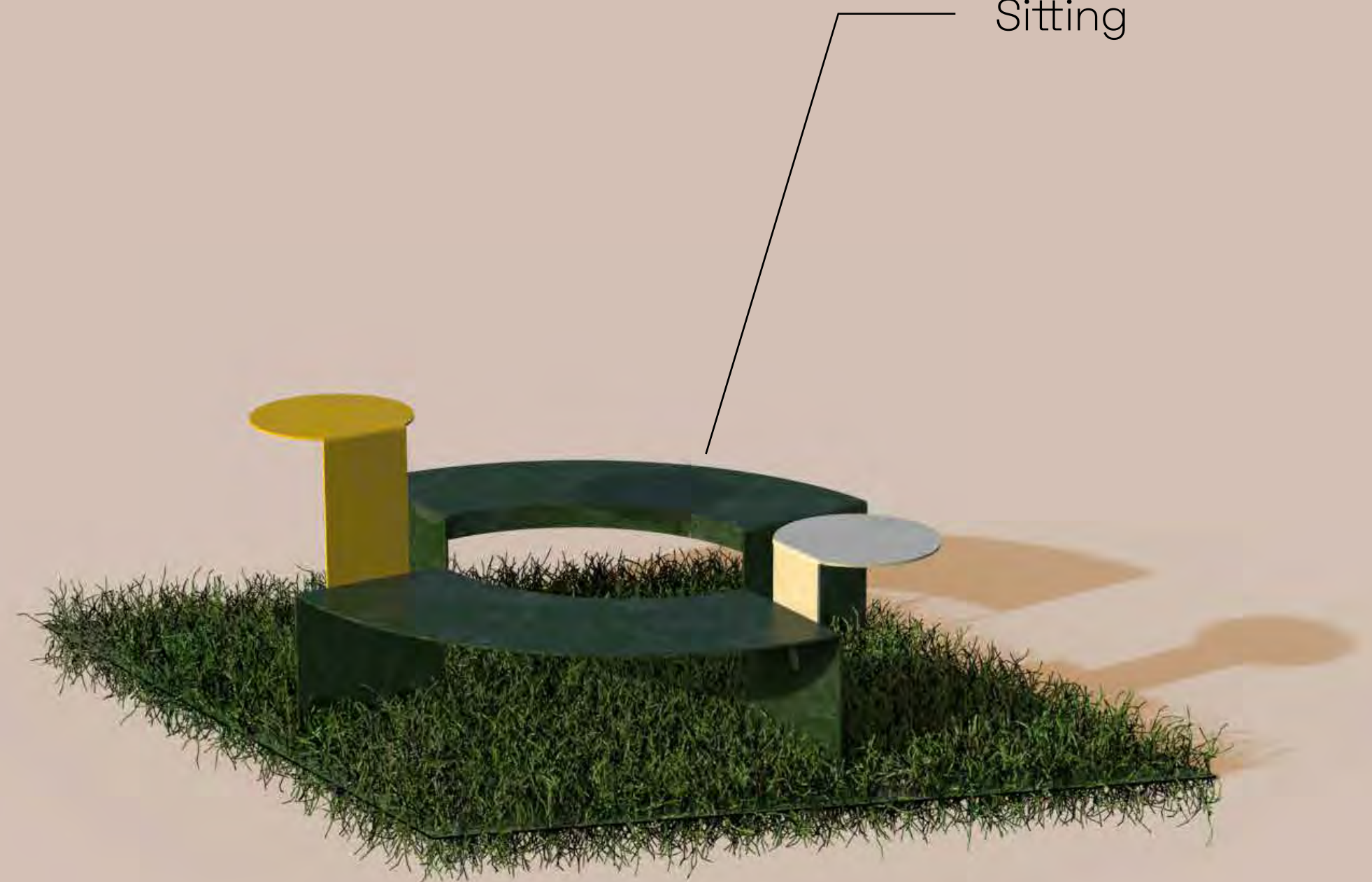



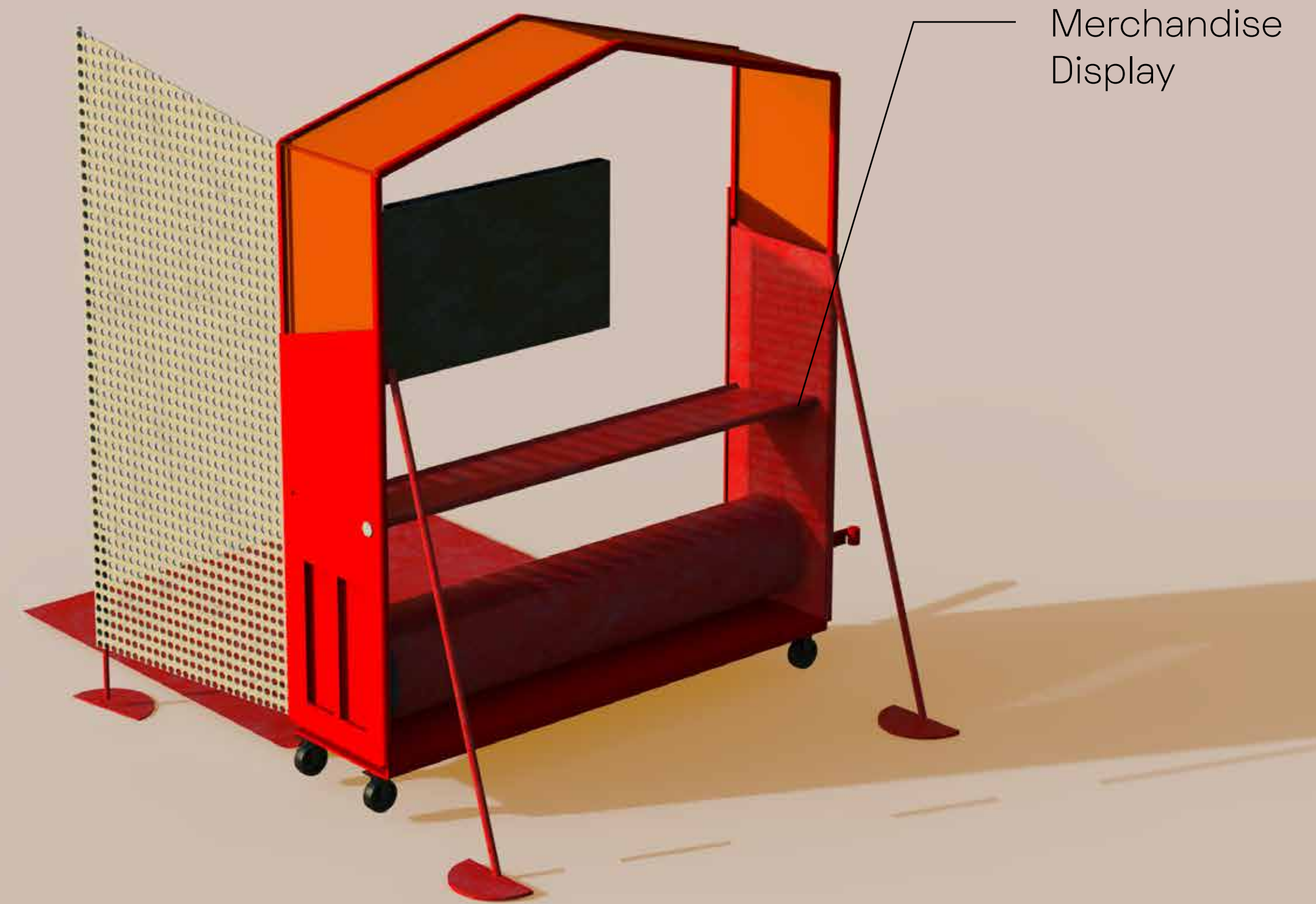
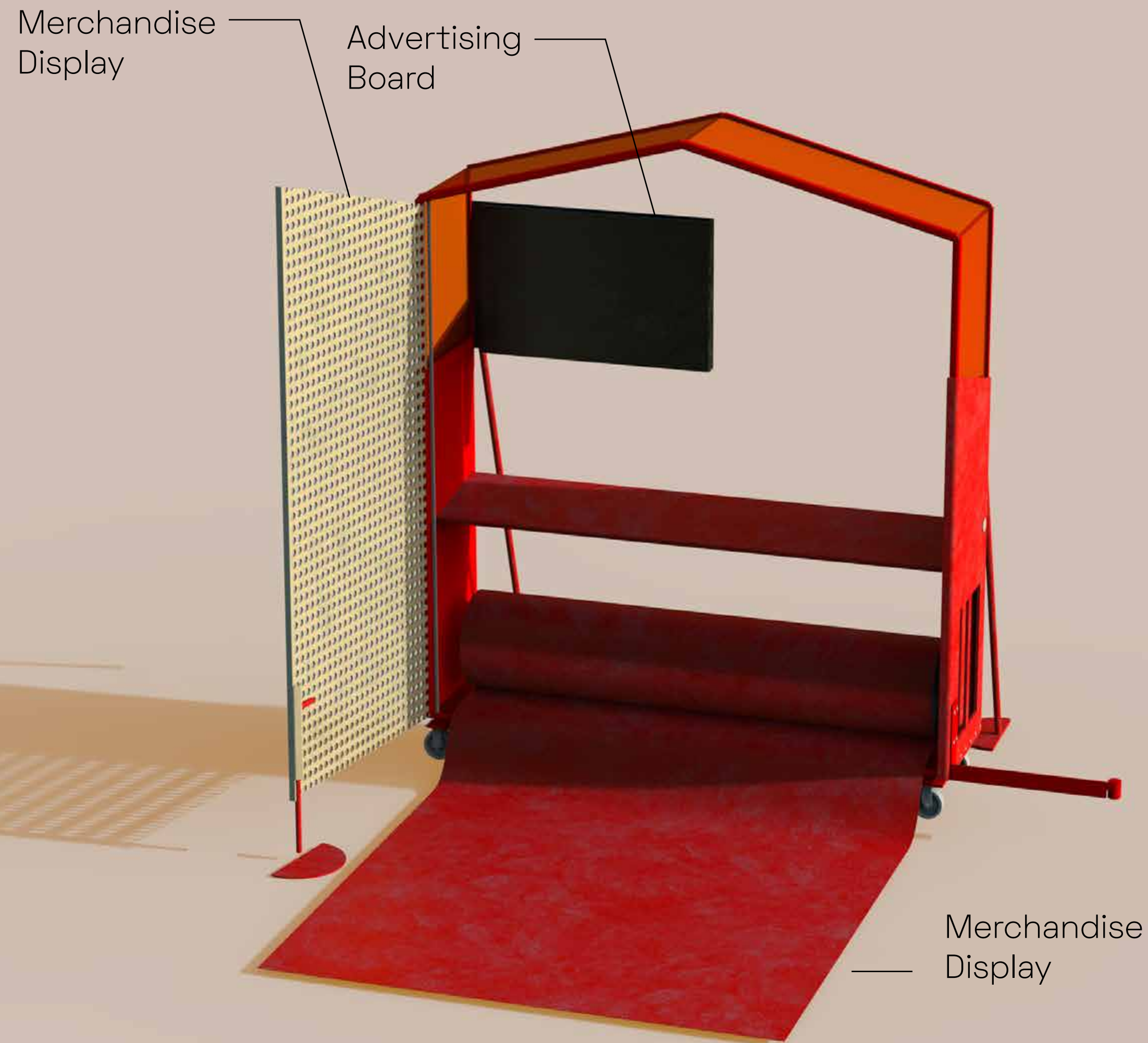



## Detail Feature

---

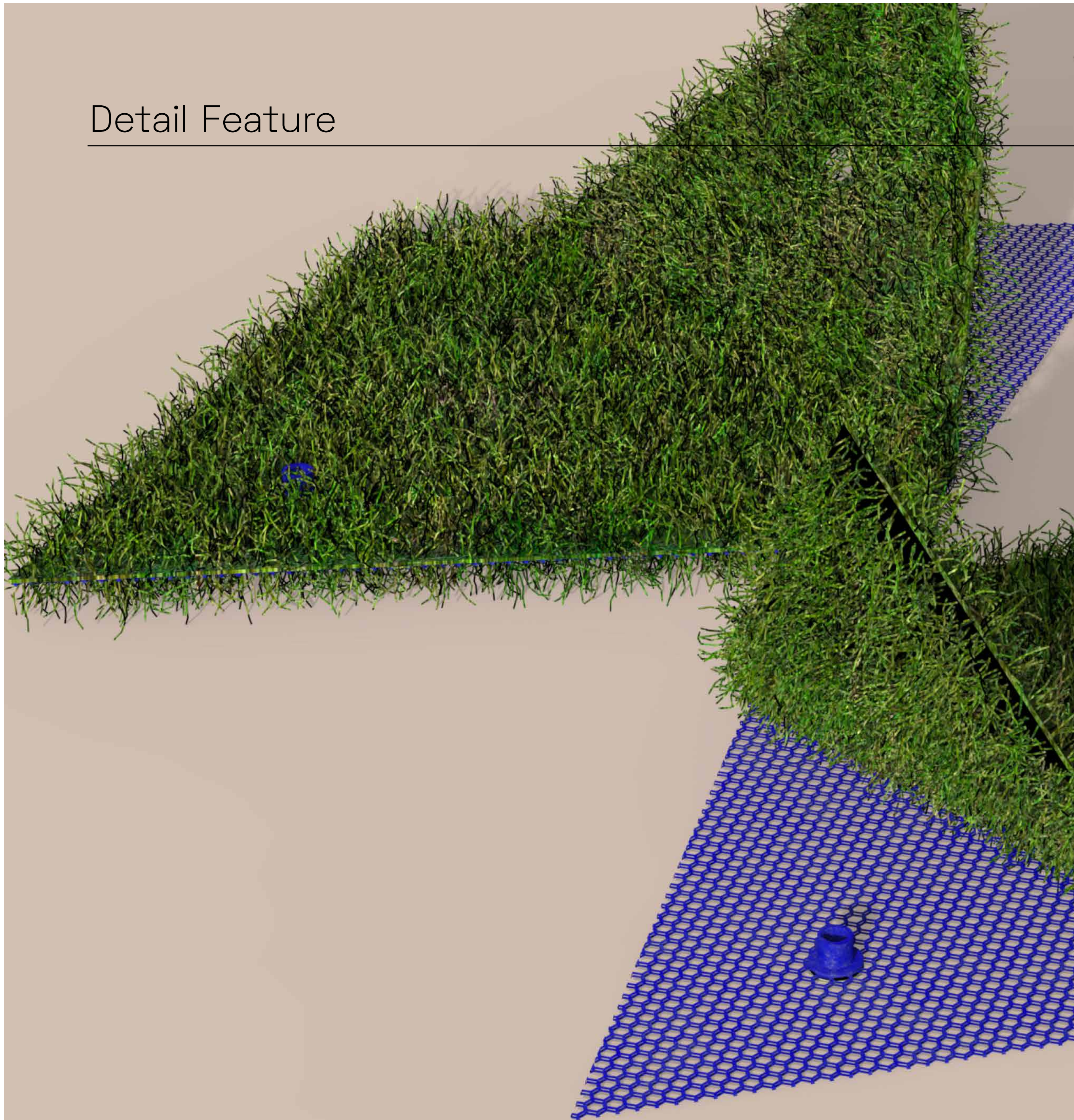

## Roaming Park L.A.

---

© Xinyi Ren

The bottom of the glass panel is attached to a layer of stainless steel chain mesh that sustains the strength and, at the same time, fixes all the modules to the ground. The grass panels are attached; when disassembled, the grass panel could be rolled up to save space for storage.



## Detail Feature

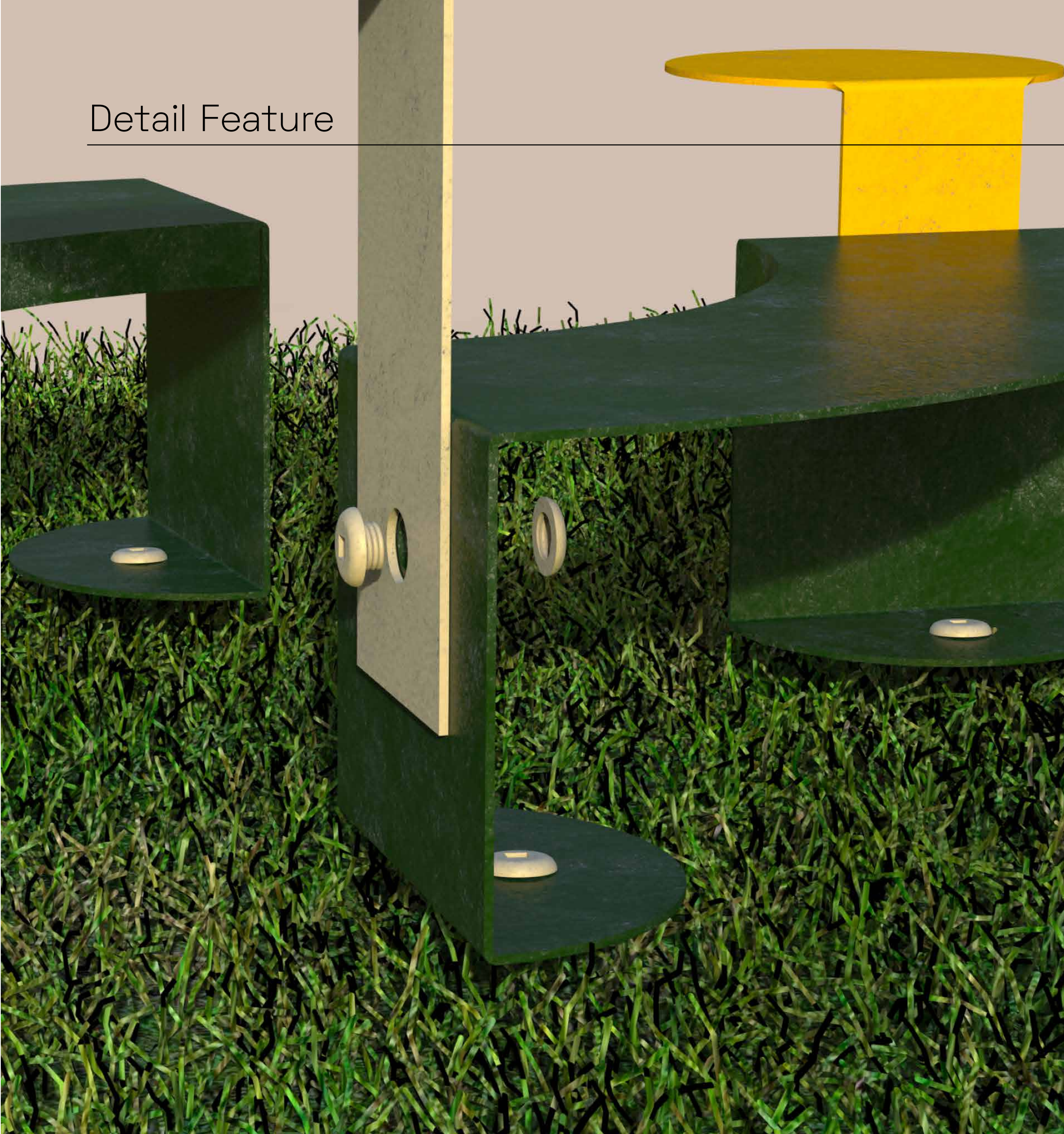

## Roaming Park L.A.

© Xinyi Ren

All the modular parts are assembled with screws that require our specific tool to mound and dismantle to ensure the security of the modules.



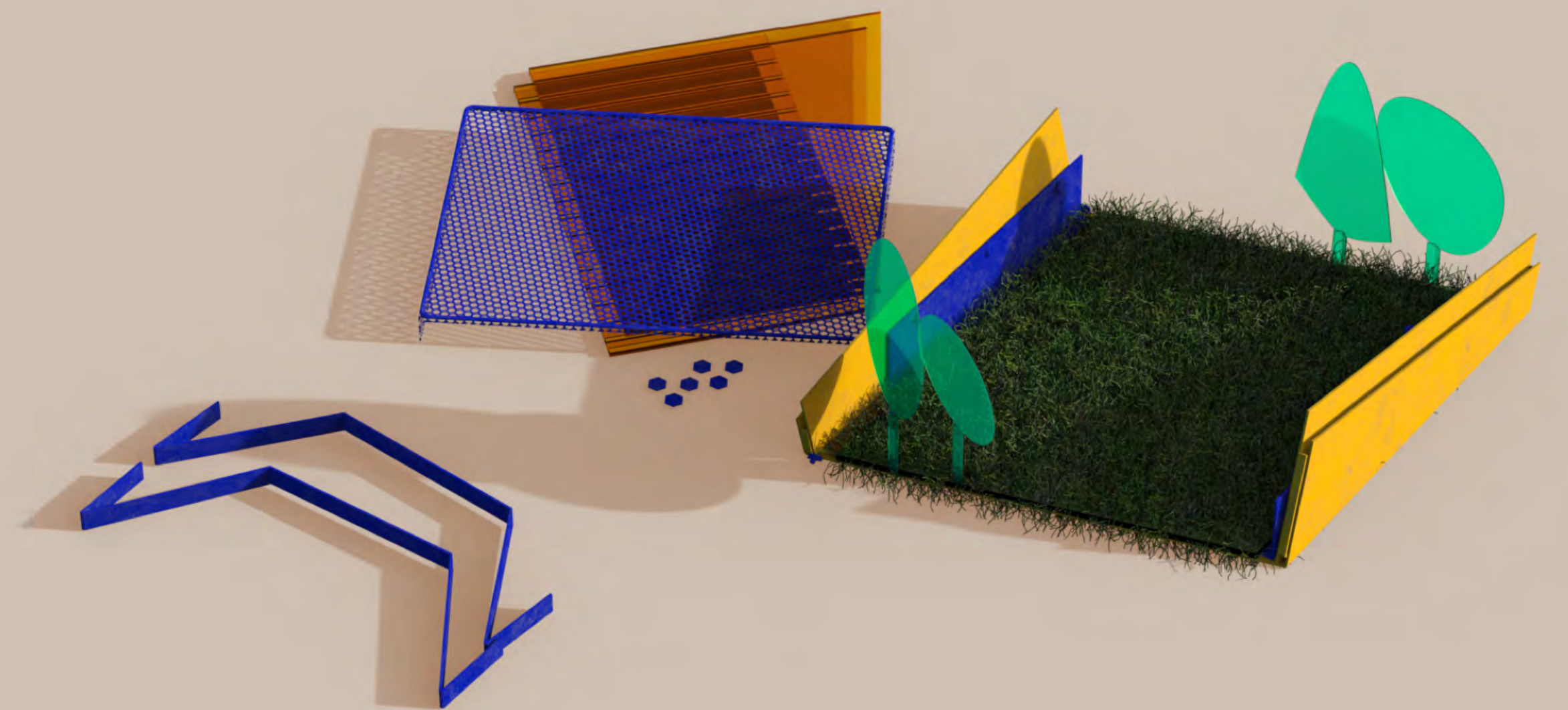
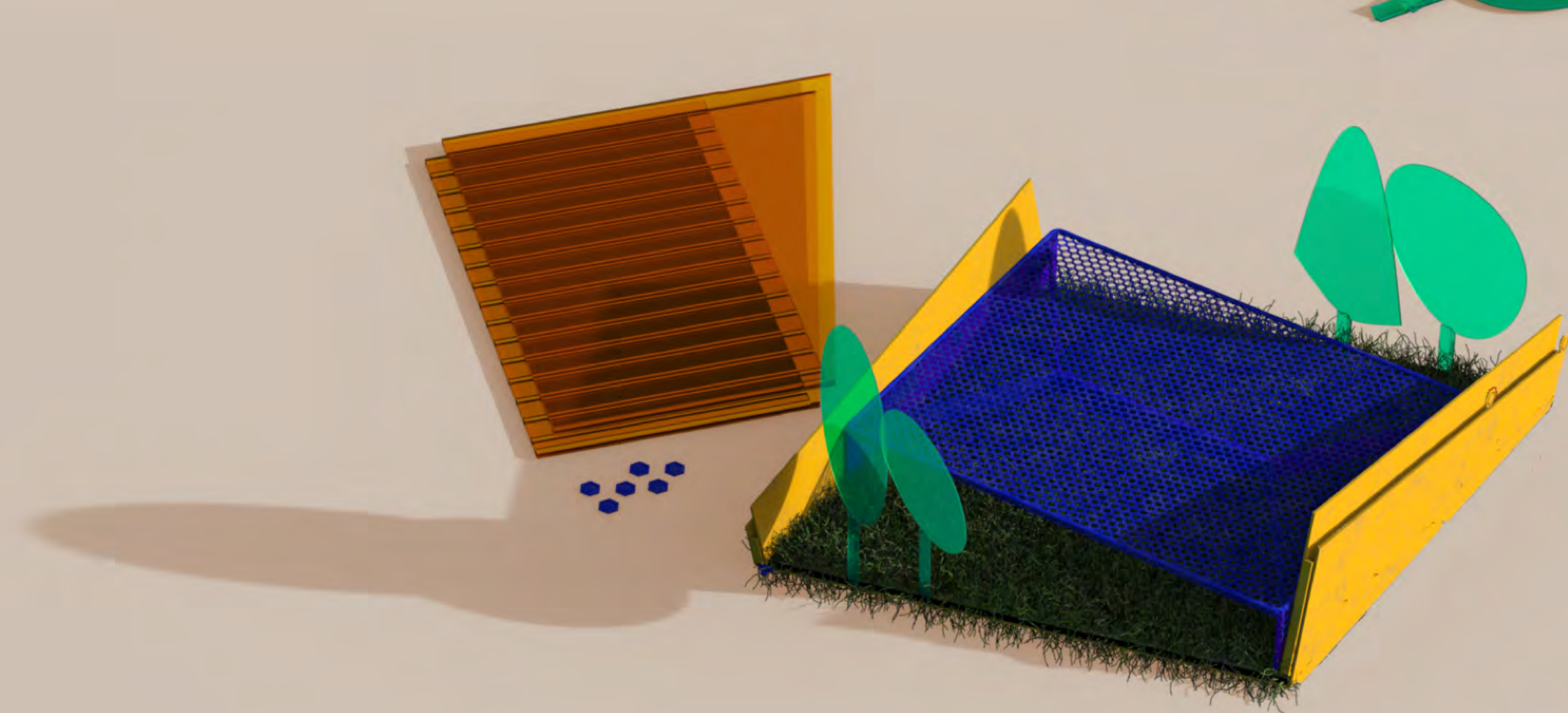
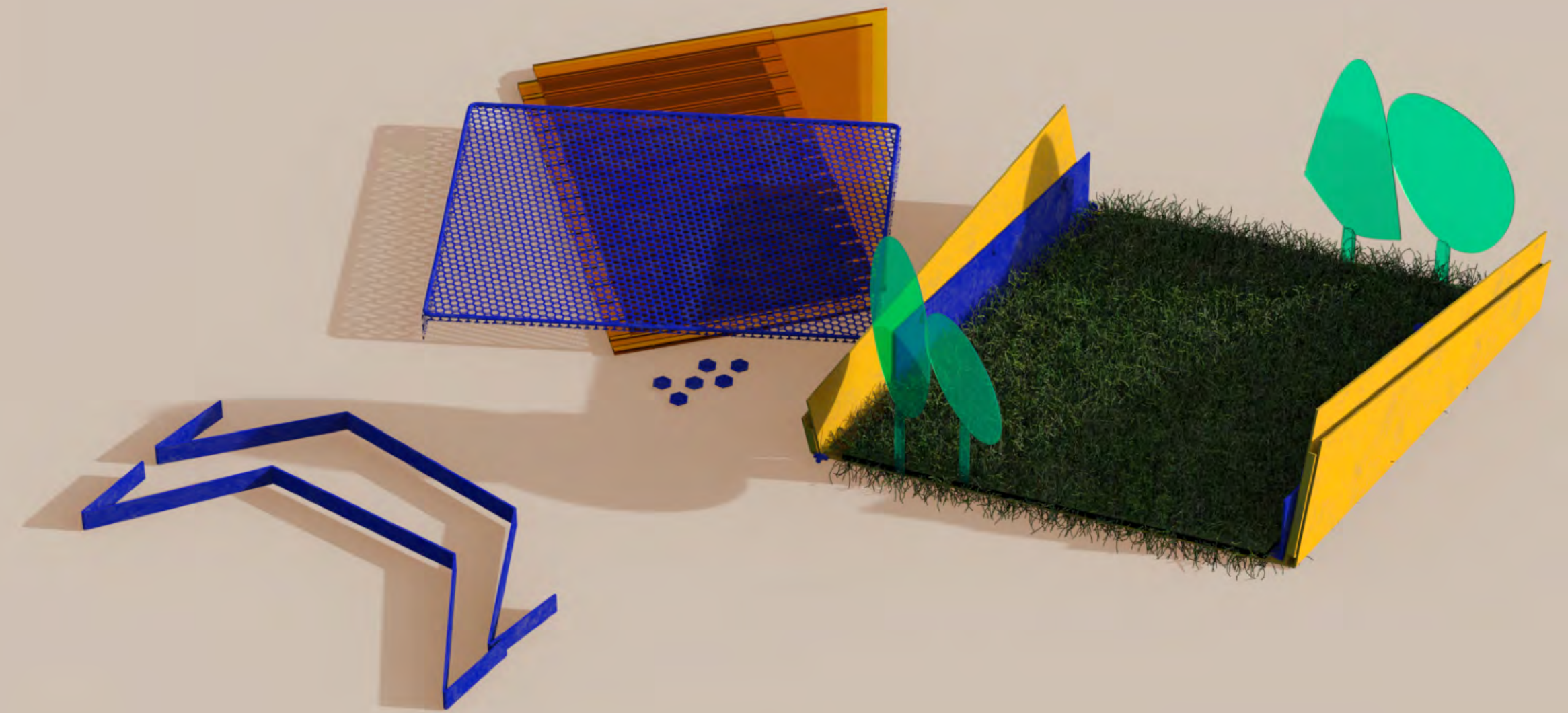
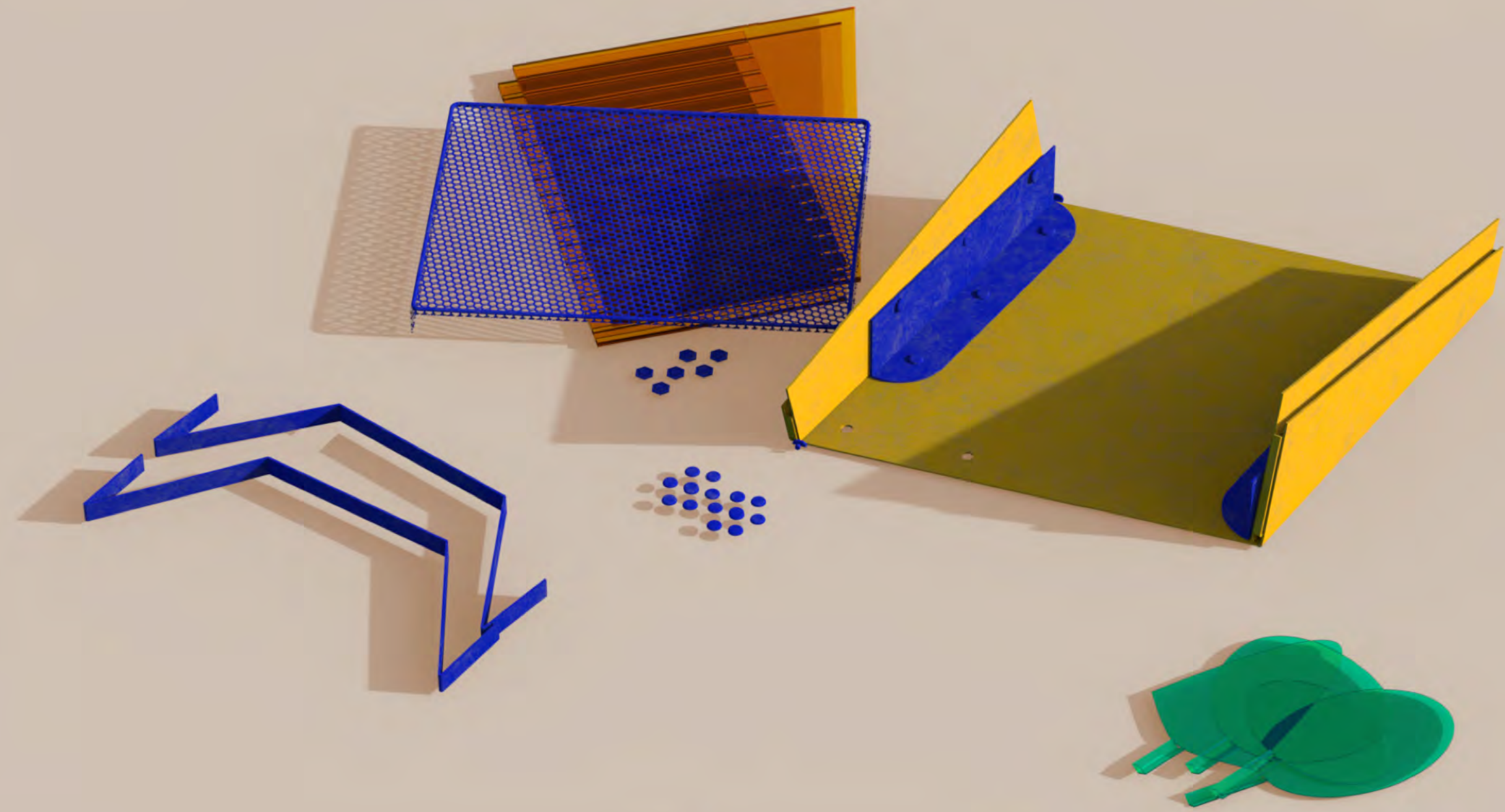



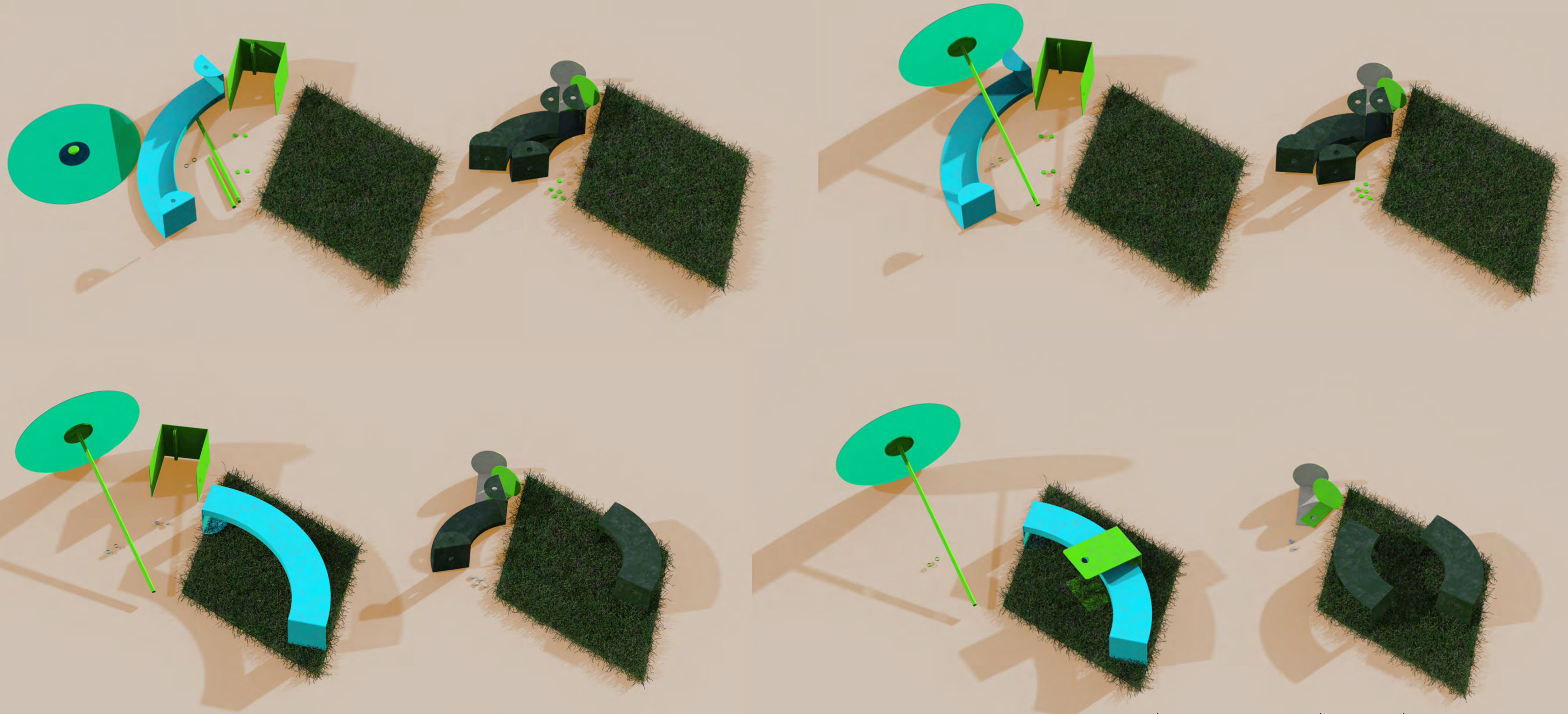



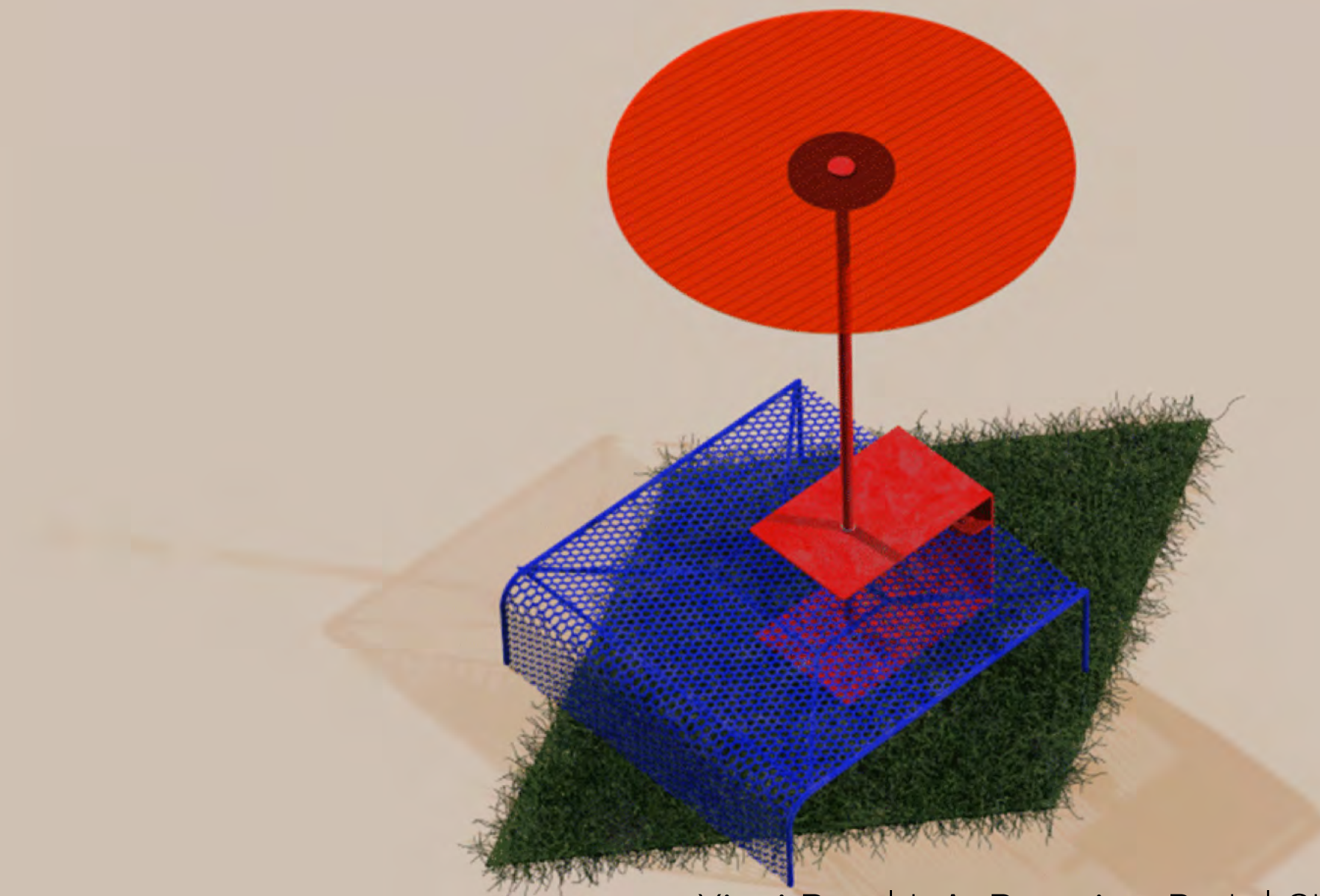
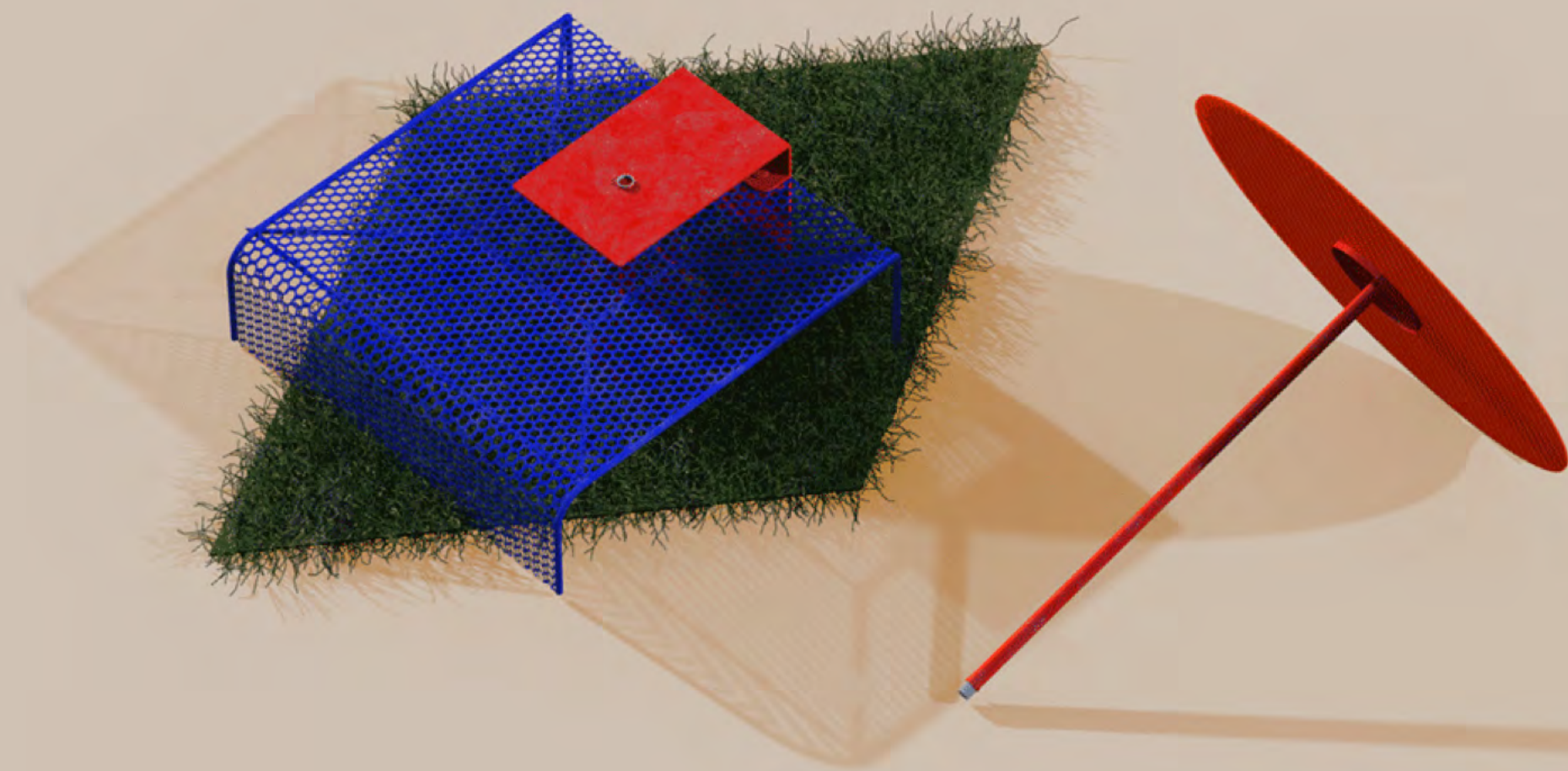
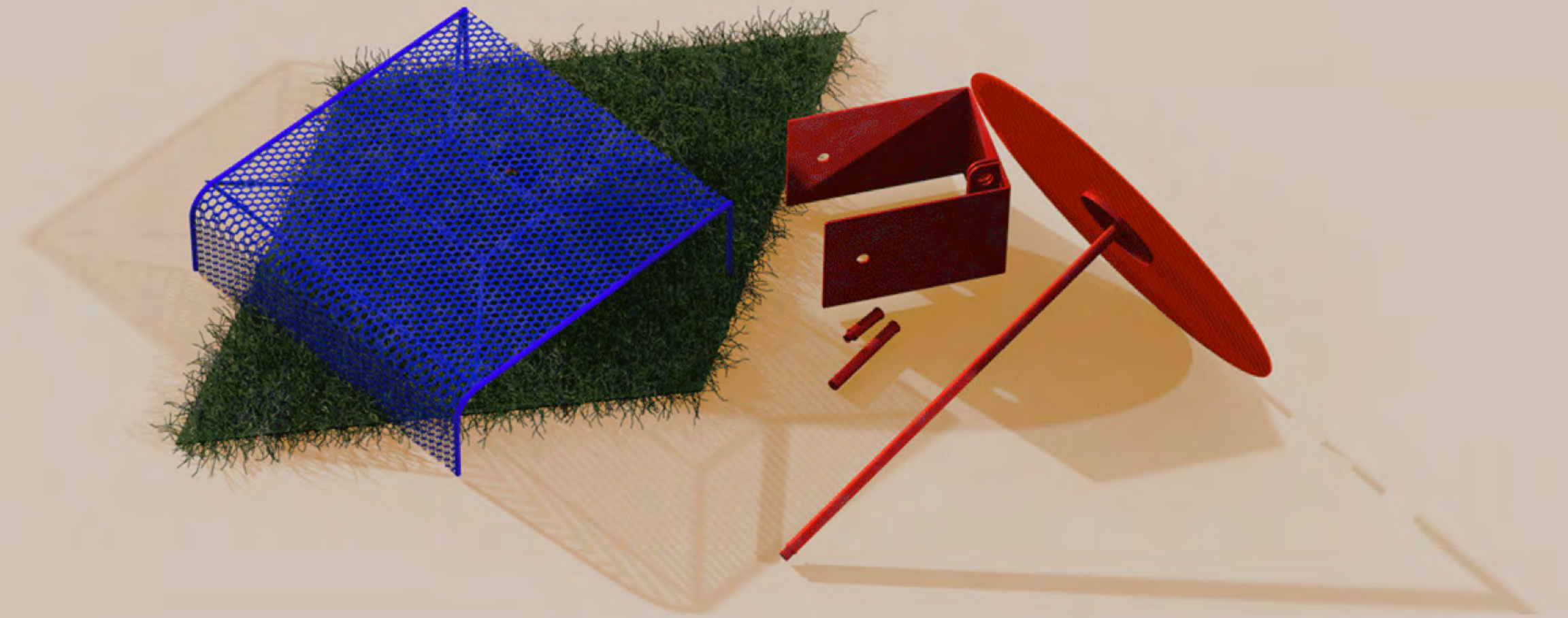
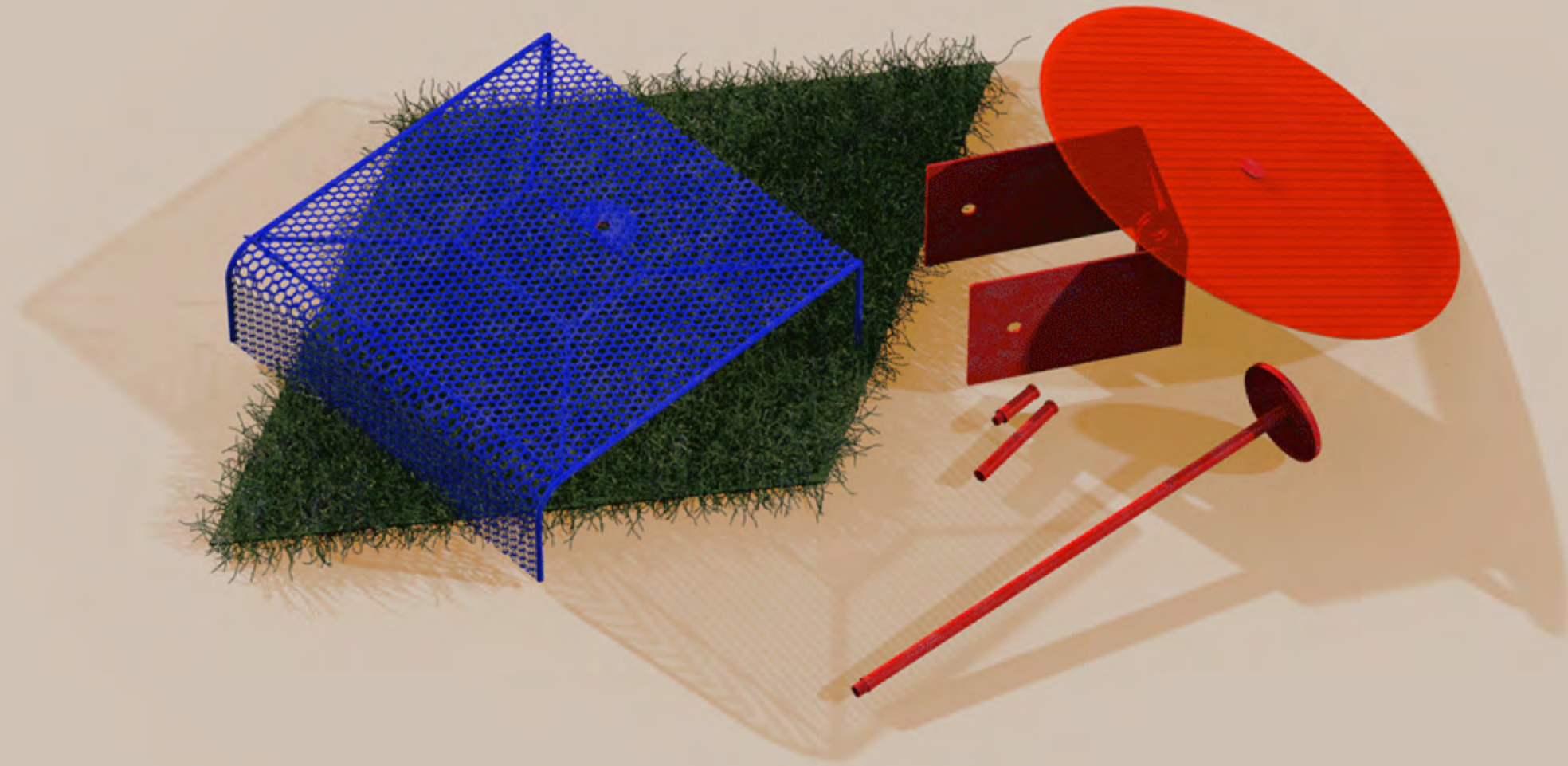



Assembly - Mini Market

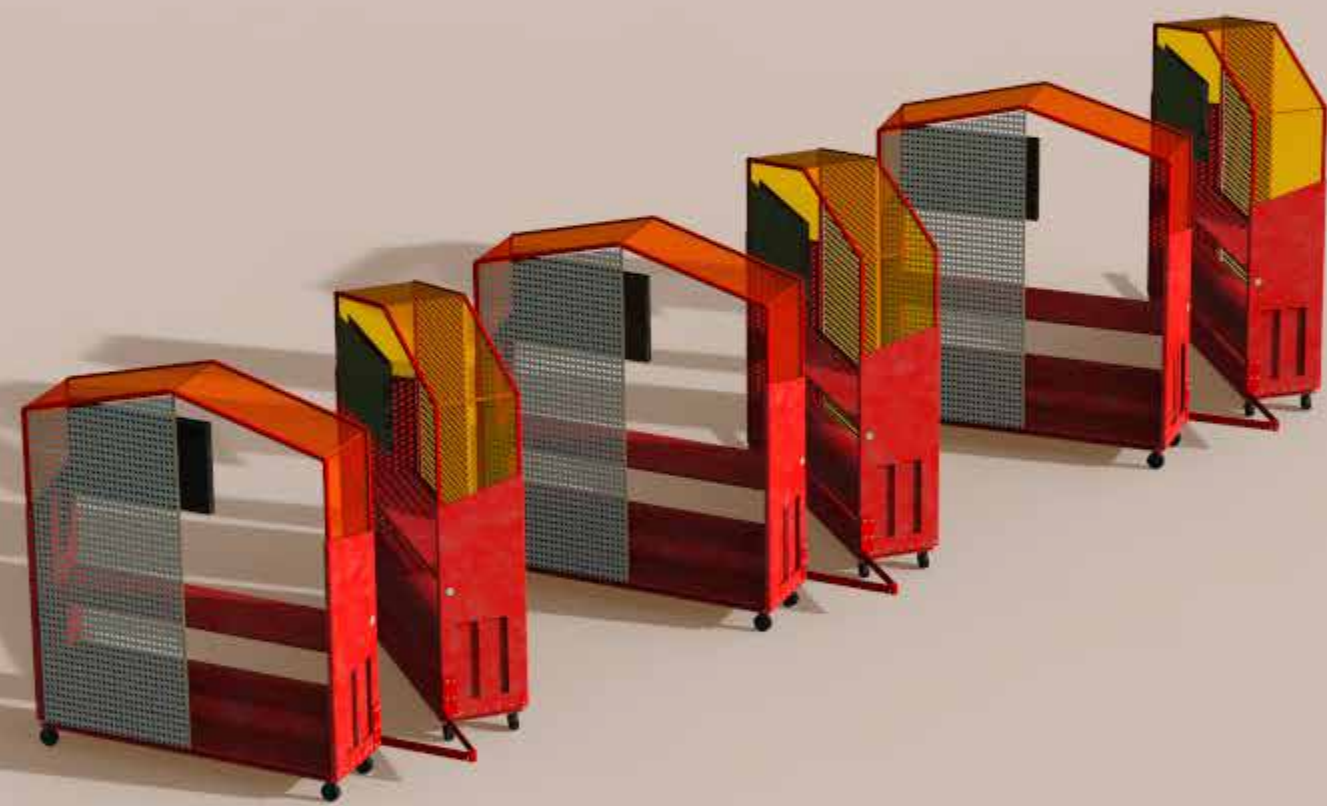
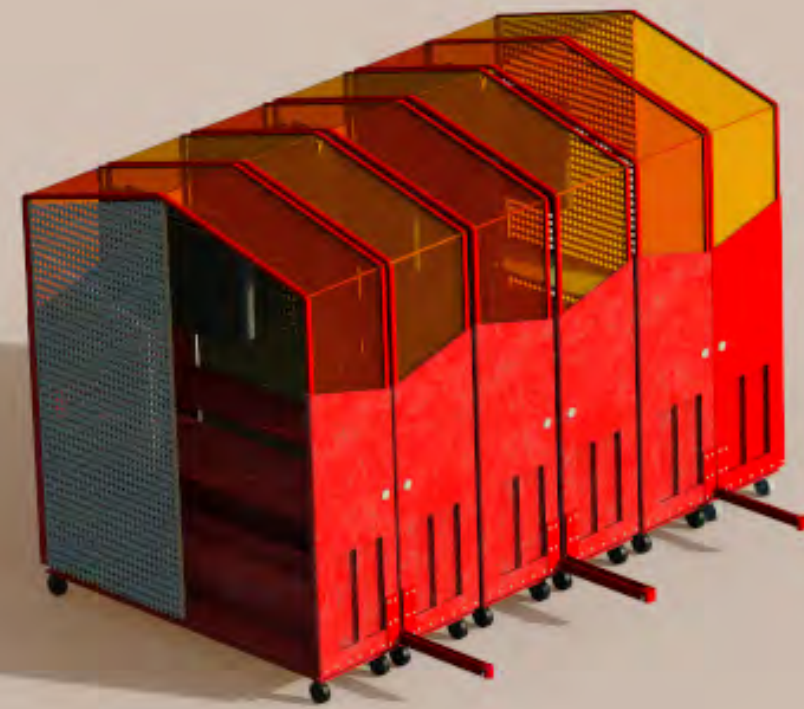

Roaming Park L.A.

© Xinyi Ren

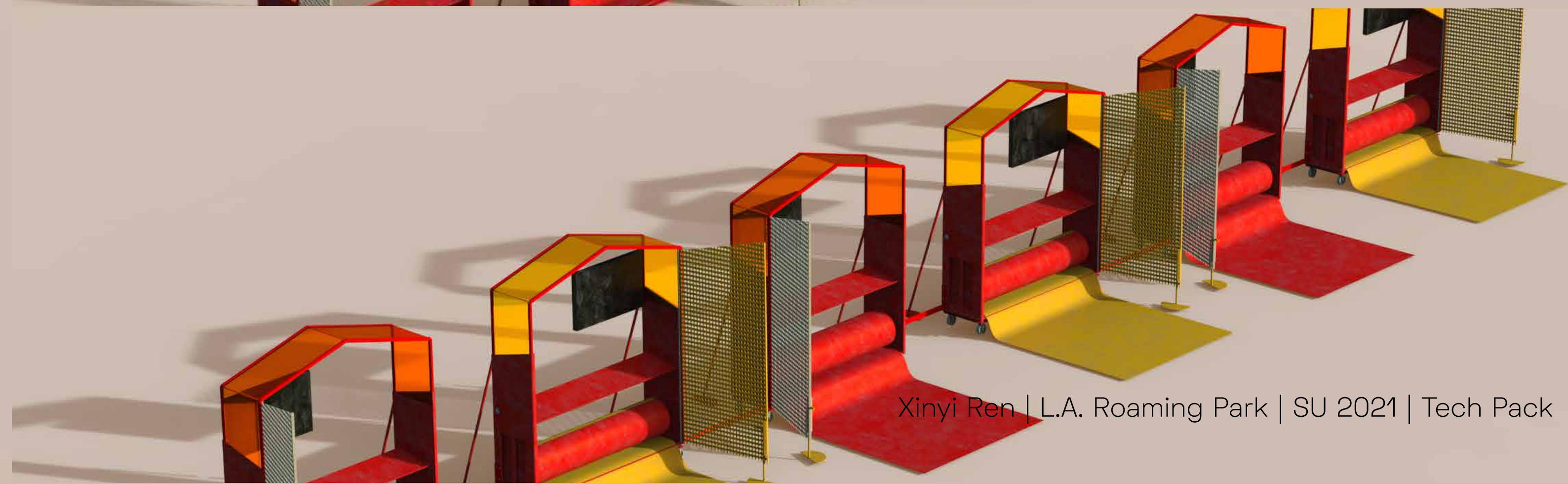
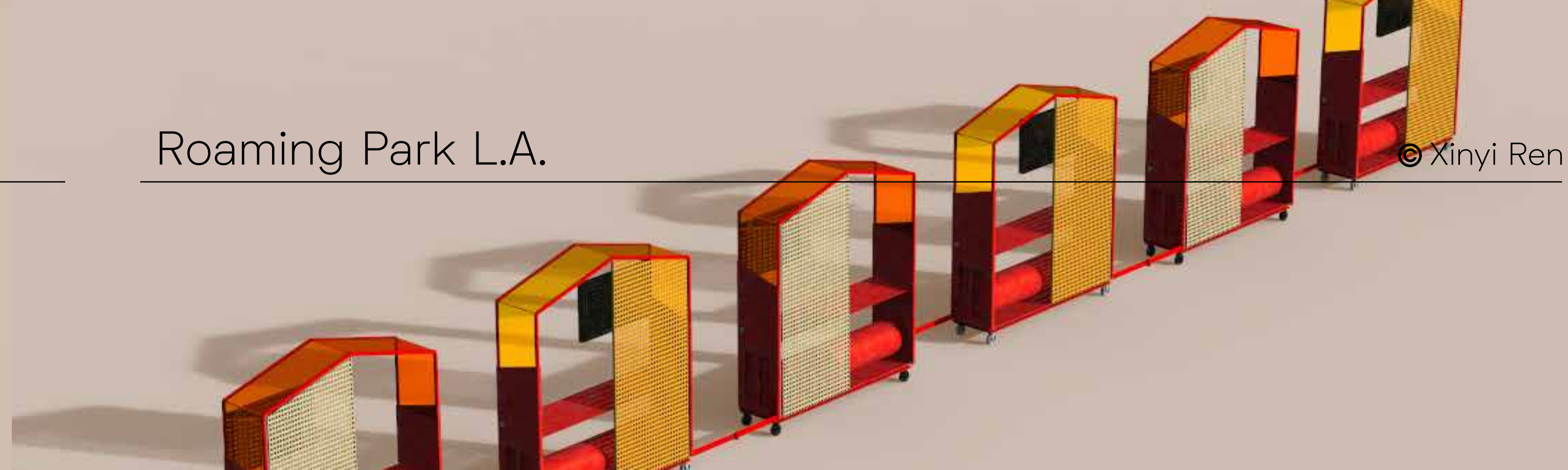



## (Perforated) steel sheet

- Industrial Metal Supply Co.
  - Steel Sheet
  - Product model: HRP012410PO
  - Length & width 120in \* 48in
  - Thickness 12 Ga (0.1094 in)
  - Specification ASTM-A1011
  - Weight Ea. 175.00#
- Perforated Steel Sheet
  - Product model: PSS1648750
  - Length & width 120in \* 48in
  - Thickness 16 Ga (0.0625 in)
  - Hole Pattern 3/4 in round (51% open)
  - Weight Ea. 50.00#



## Polycarbonate panels

- DANPALON®
  - FACADE SYSTEMS
    - Multicell / Honeycombe 8mm
    - Span between support: up to 1.6m
    - Impact & Shock Resistance
    - Ten year warranty
  - GLAZING MATERIALS & FINISHING

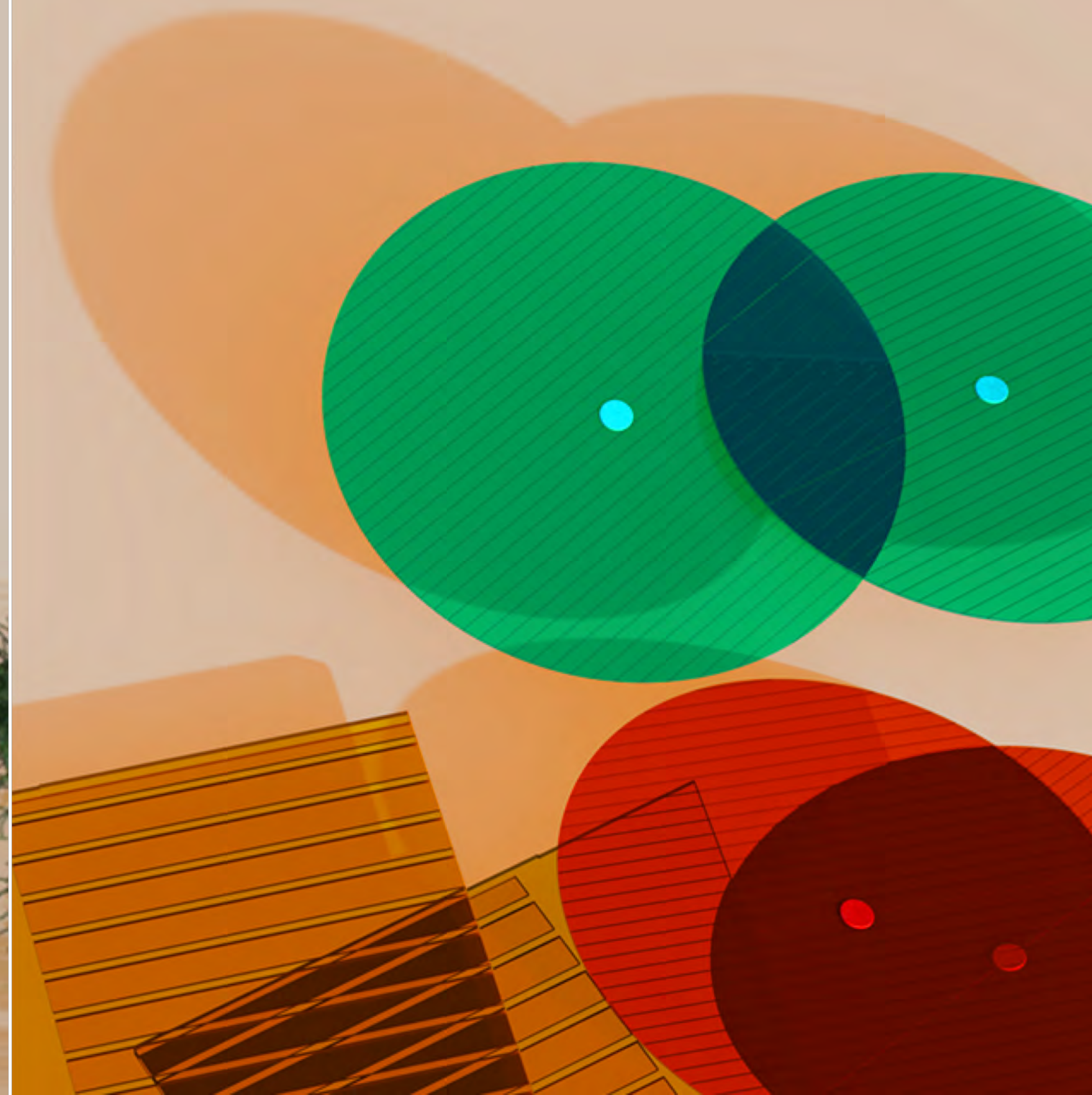

## Expanded Steel Sheet

- Industrial Metal Supply Co.
  - Product model: FXM050134824
  - Design Size 1/2 in
  - Width 48in
  - Style 13# (0.0938 in)
  - Type Flat Expanded
  - Weight Ea. 11.20#

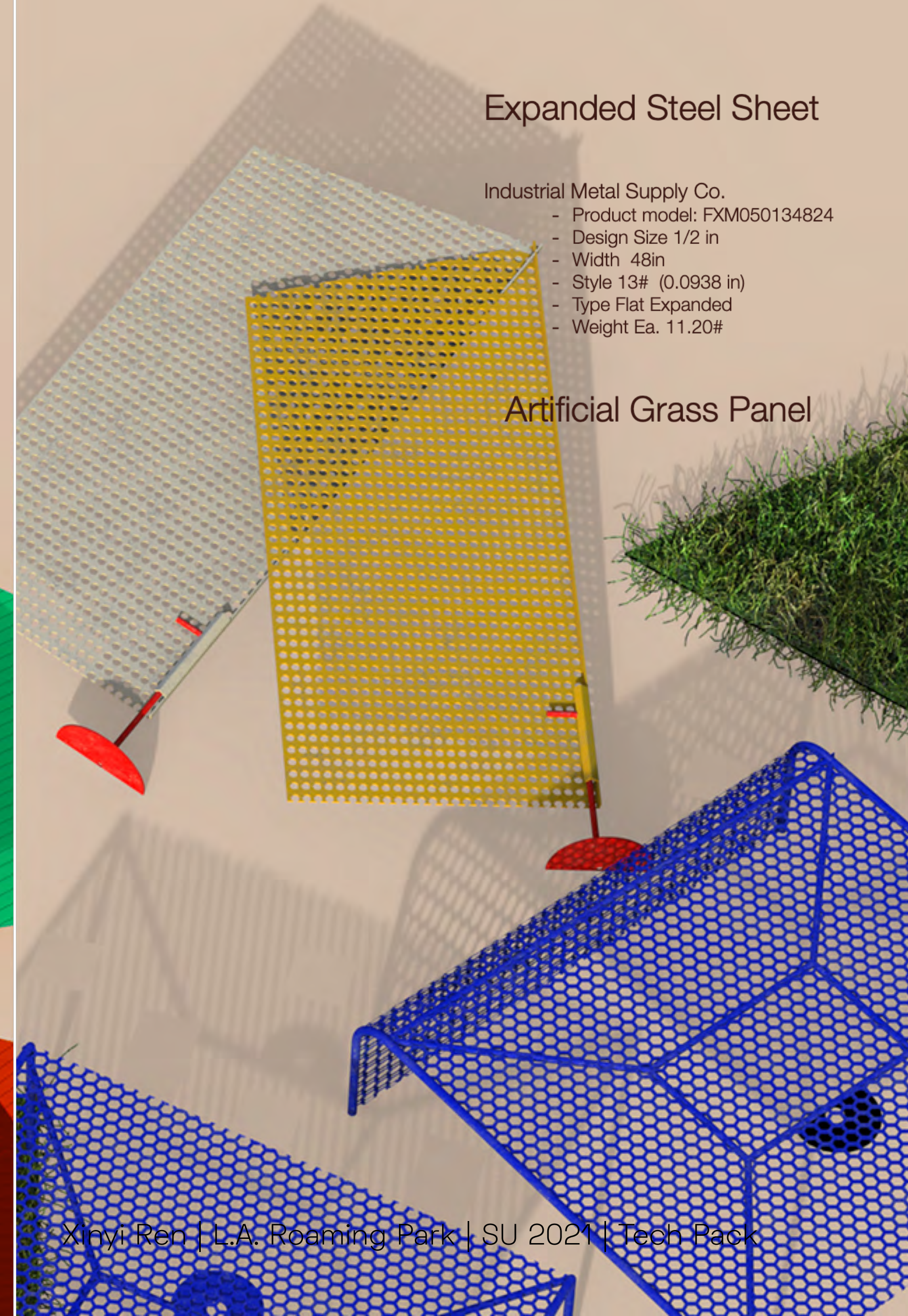

## Artificial Grass Panel



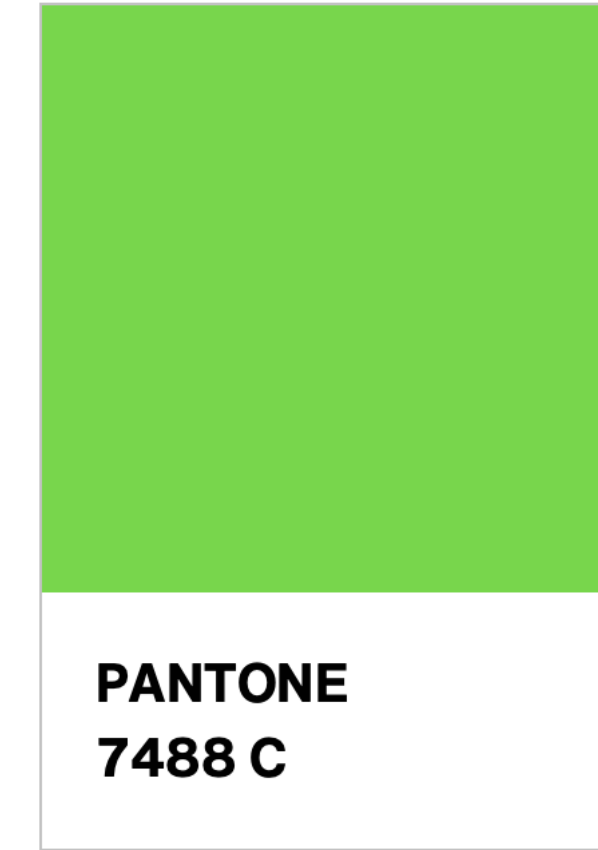
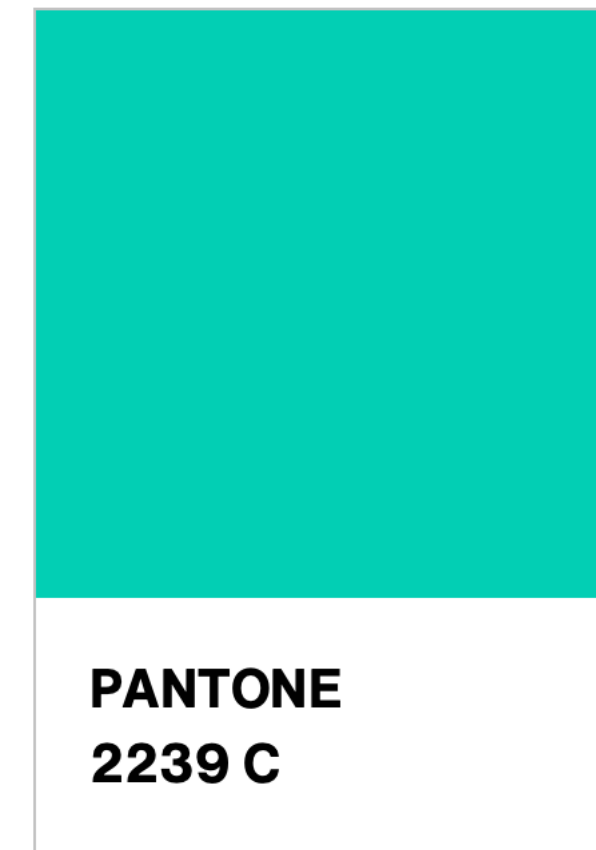
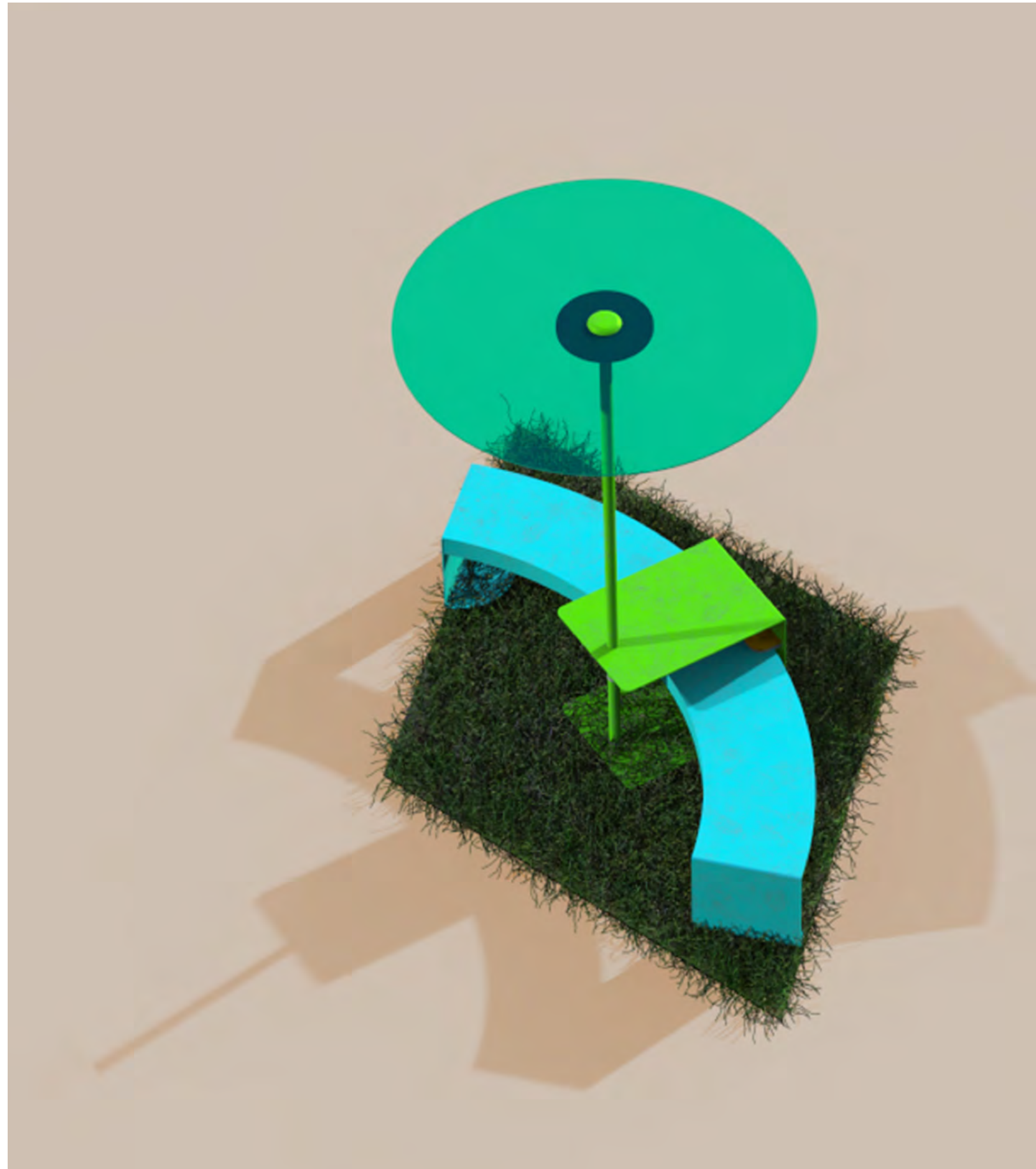

Puzzle Sitting 01



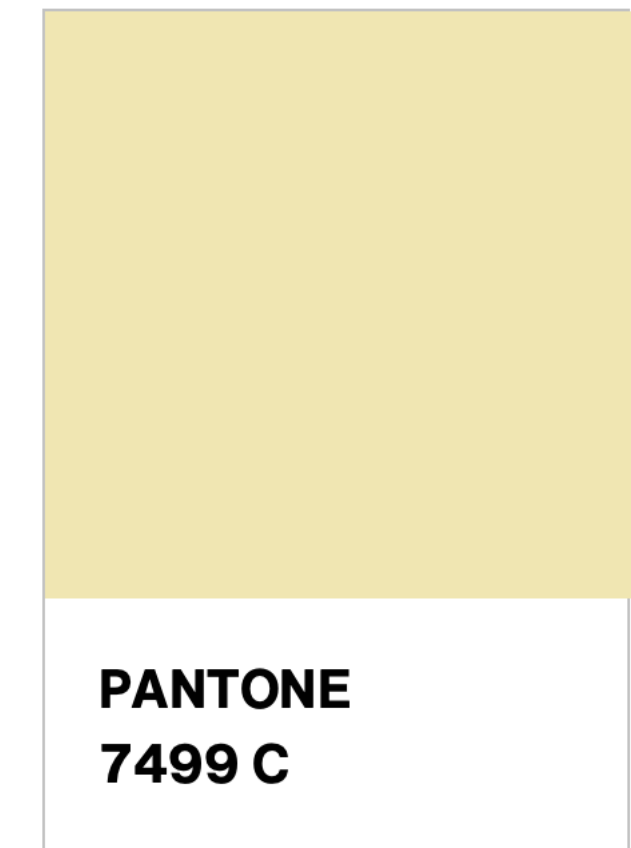
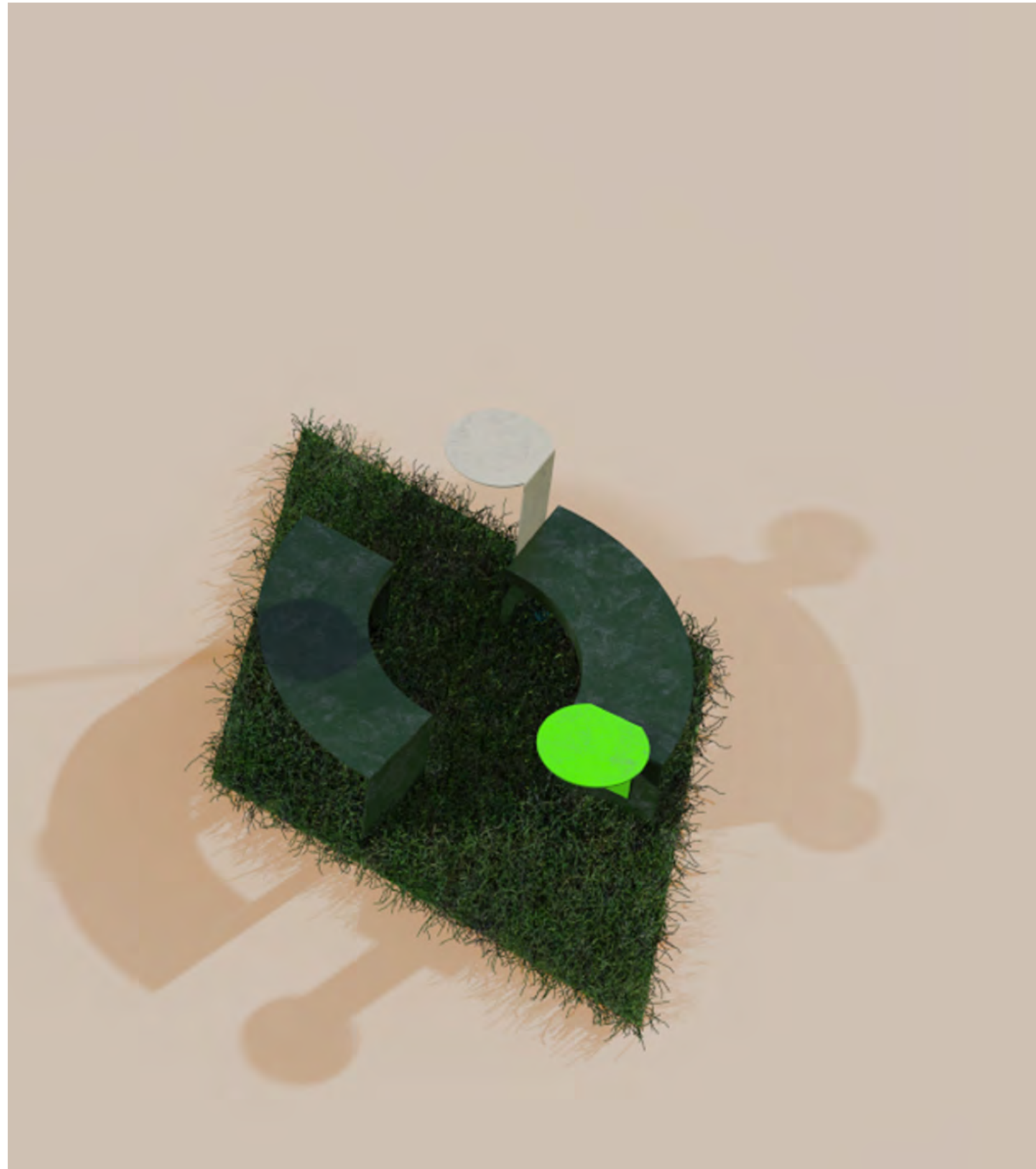

Puzzle Sitting 02



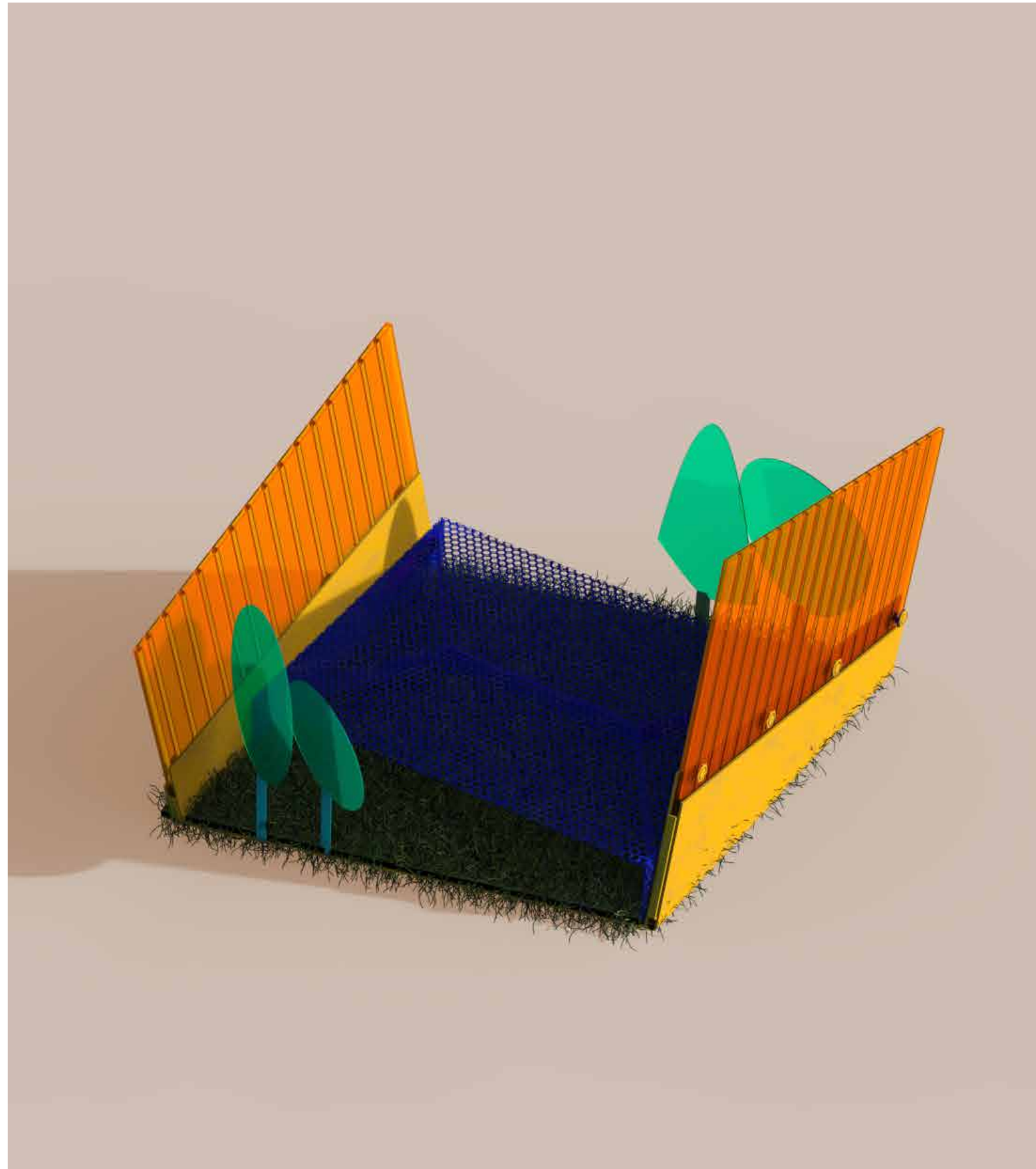

Picnic Module

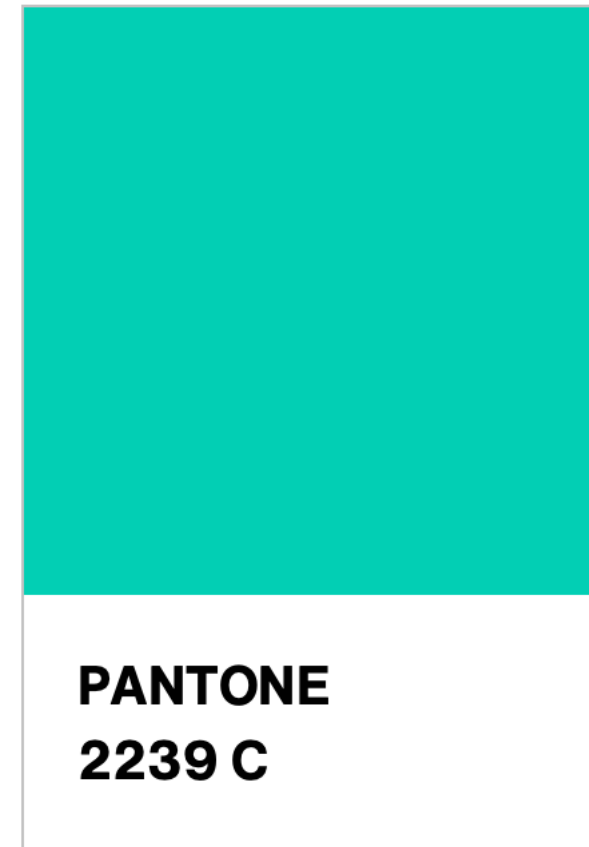





**PANTONE  
3516 C**

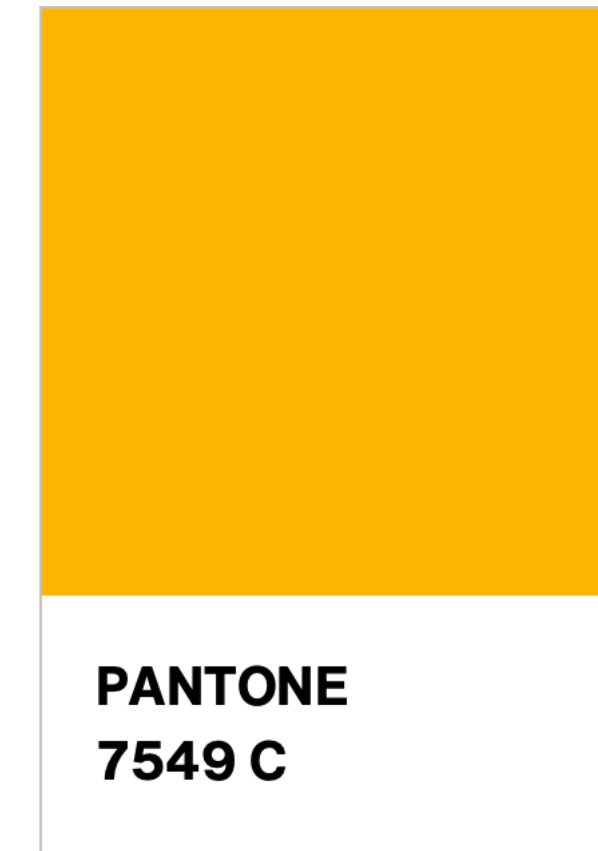

**PANTONE  
7549 C**

Mini Market



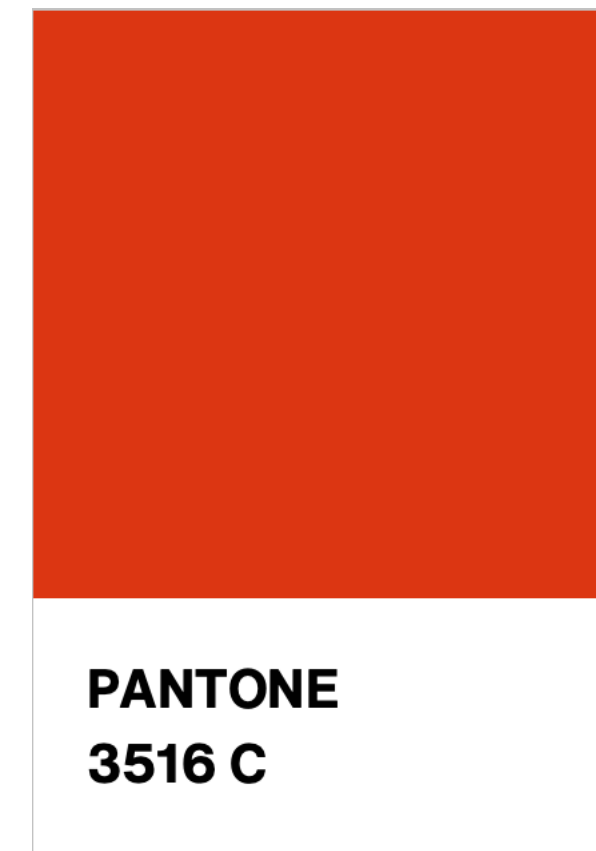
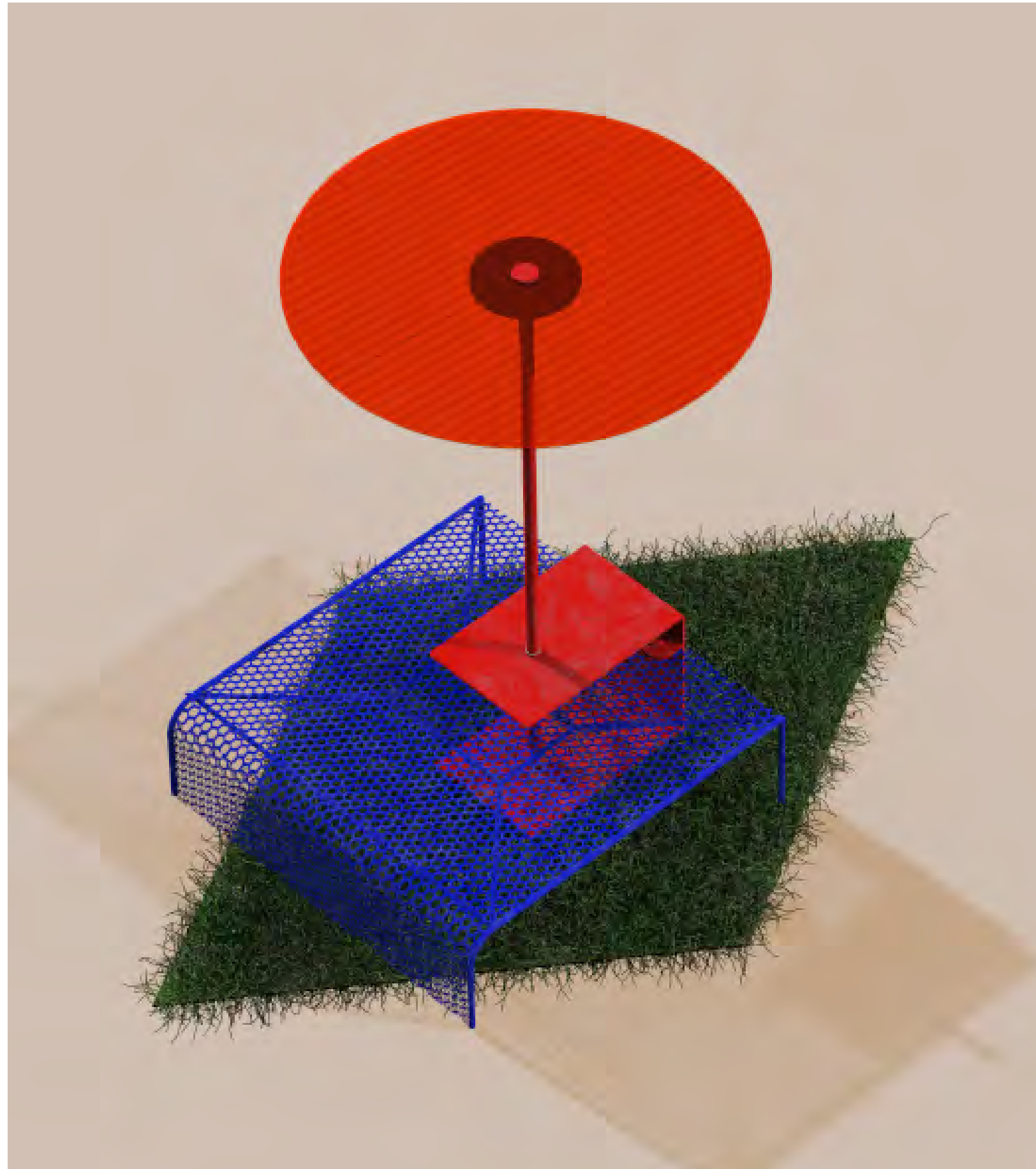

Group Gathering



8 7 6 5 4 3 2 1

H  
G  
F  
E  
D  
C  
B  
A

H  
G  
F  
E  
D  
C  
B  
A

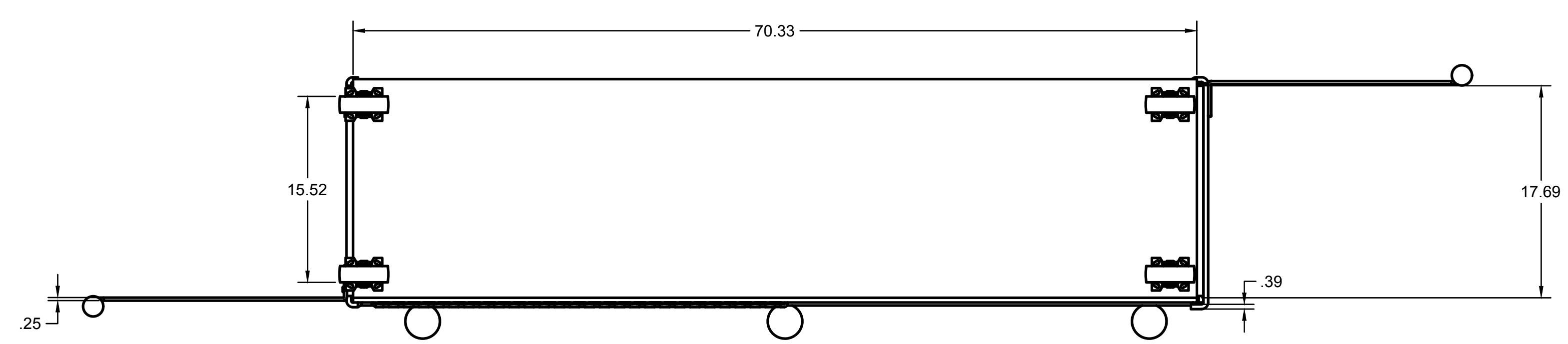
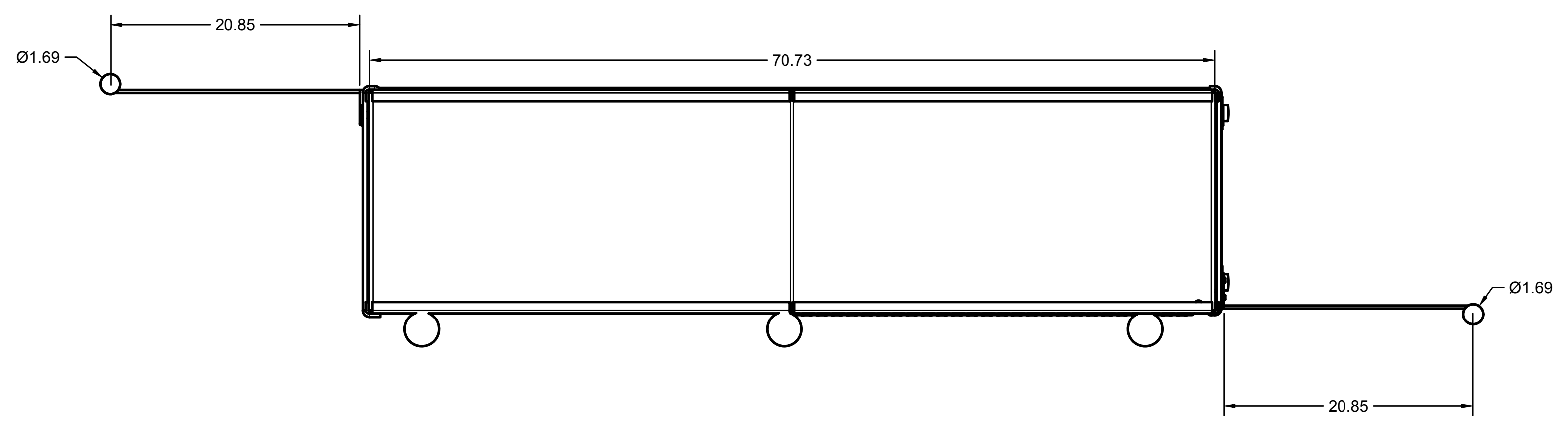
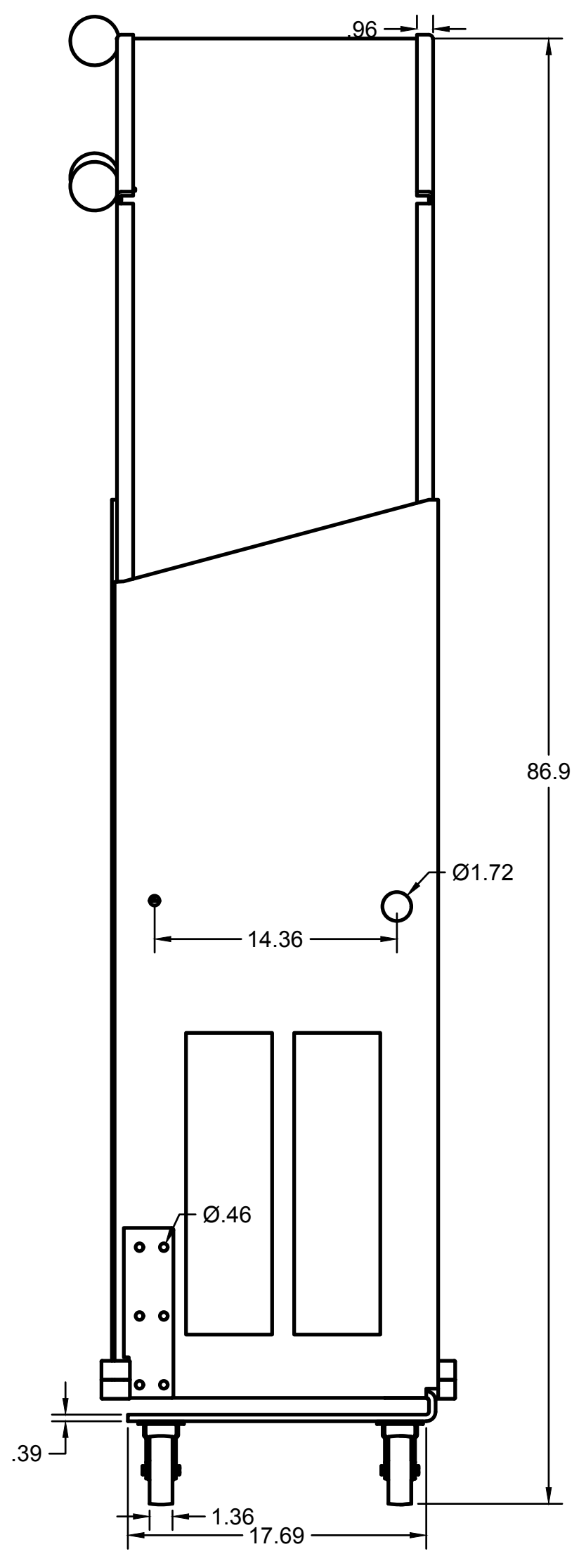
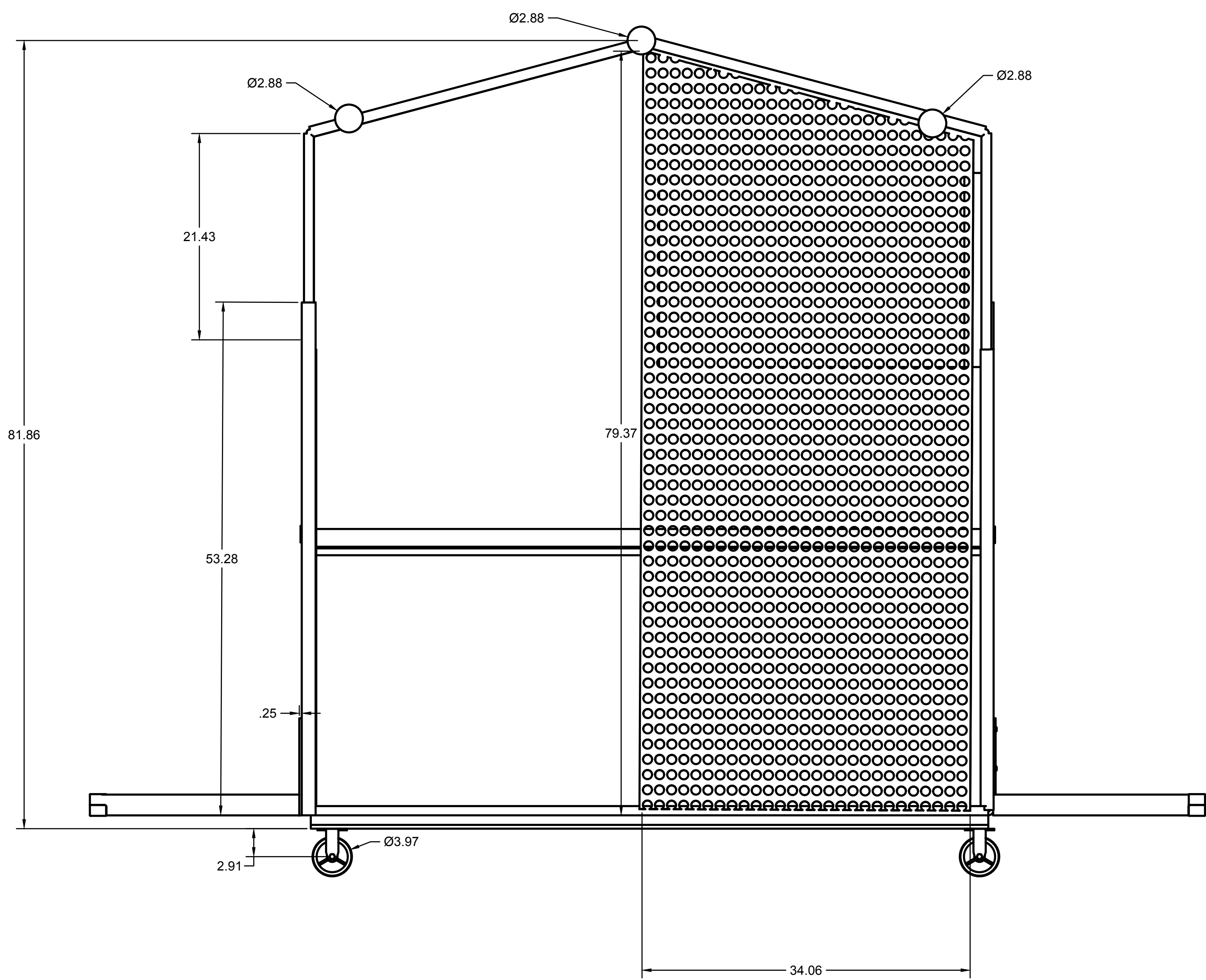

8 7 6 5 4 3 2 1

PROJECT		Admin Project		
TITLE		mini market assemble prep v2		
DIMENSION UNIT: IN				
APPROVED	SIZE	CODE	DWG NO	REV
CHECKED	E			
DRAWN	xinyi ren	8/2021	SCALE 1:8	WEIGHT
				SHEET 1/1



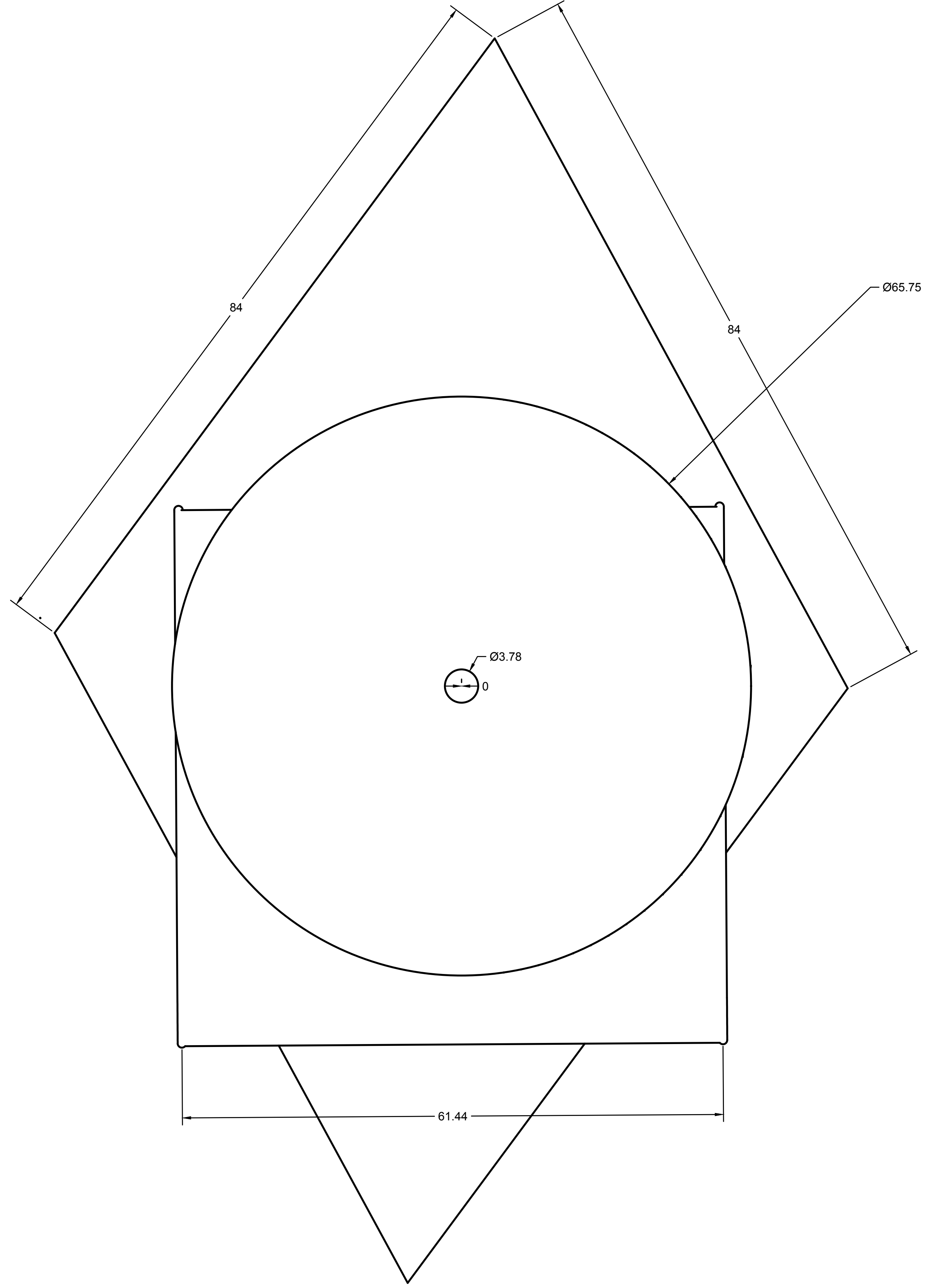
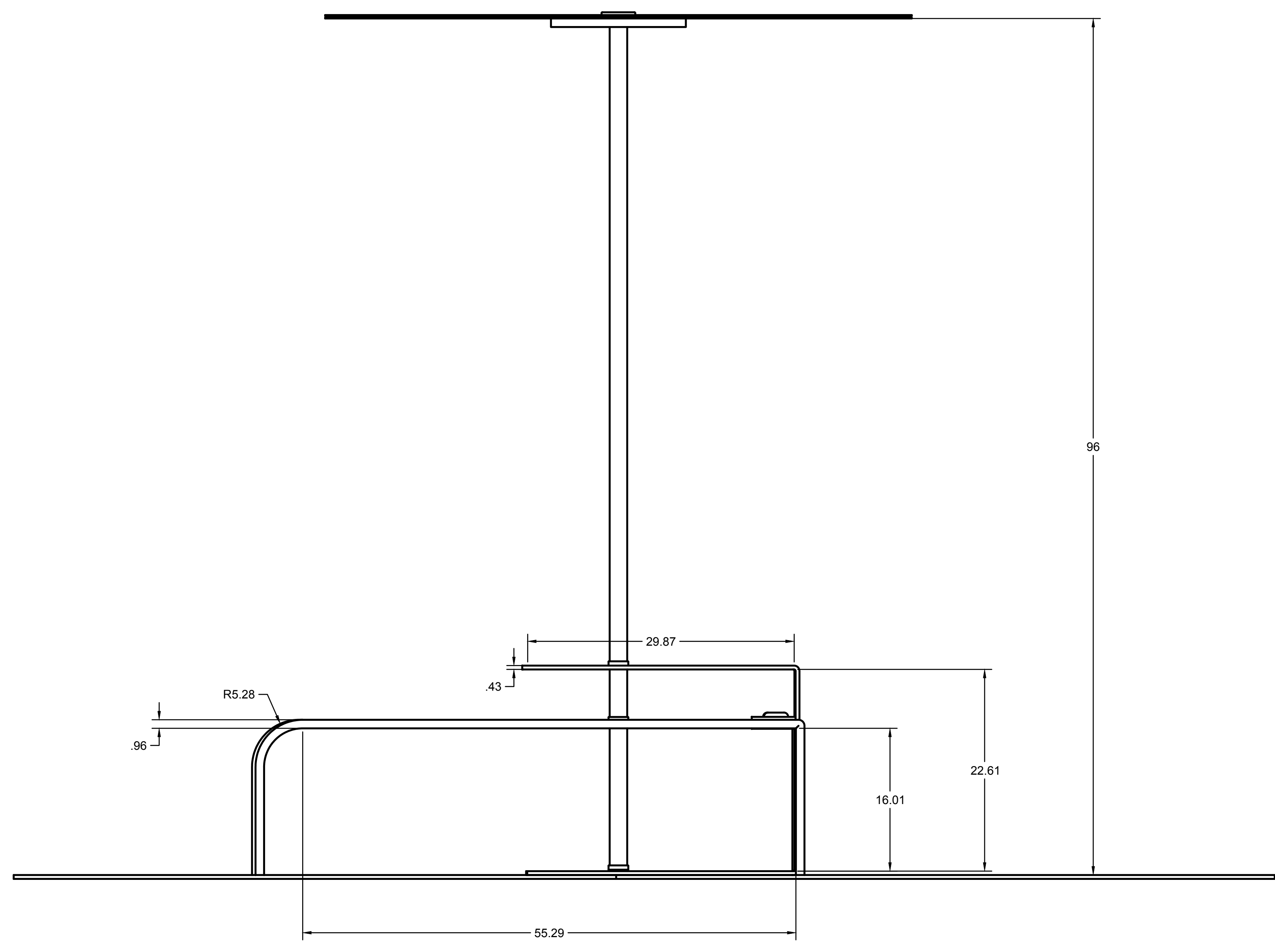
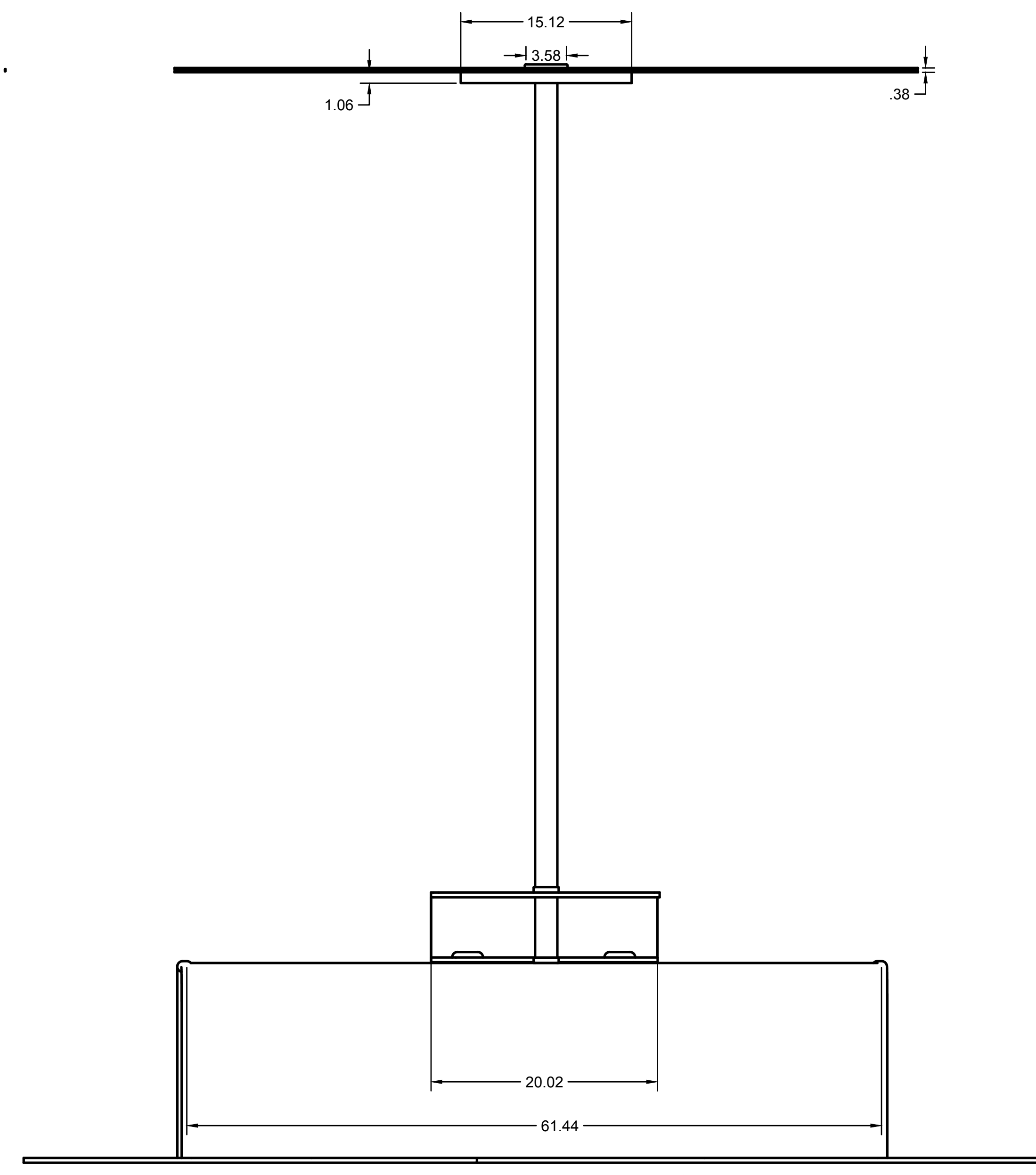

DIMENSION UNIT: IN		PROJECT Admin Project			
		TITLE Group Gathering v1			
APPROVED	SIZE	CODE	DWG NO	REV	
CHECKED	E				
DRAWN	xinyi.ren	8/2021	SCALE 1:8	WEIGHT	SHEET 1/1



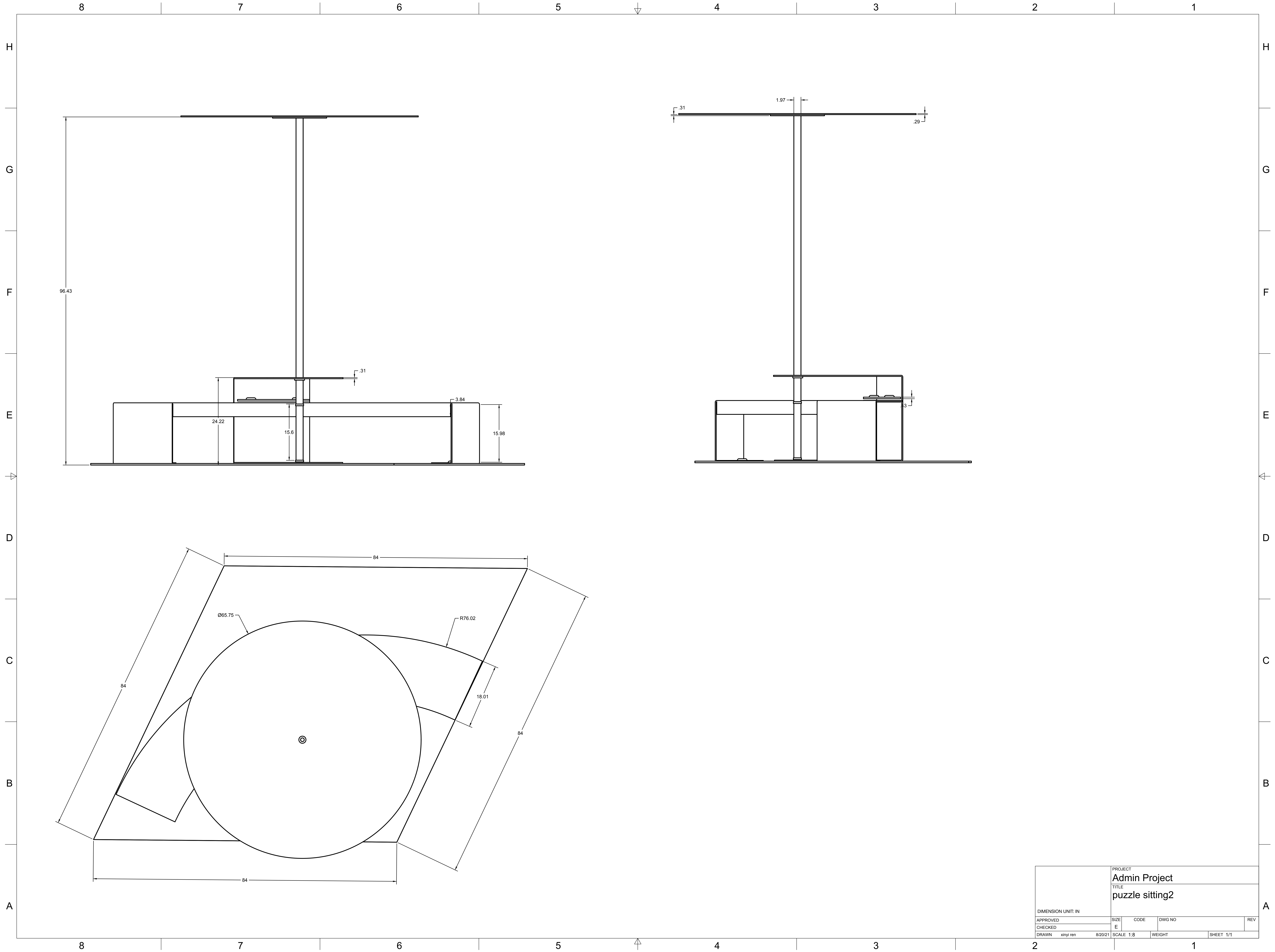

DIMENSION UNIT: IN		PROJECT Admin Project			
		TITLE puzzle sitting2			
APPROVED	SIZE	CODE	DWG NO	REV	
CHECKED	E				
DRAWN	xinyi.ren	8/2021	SCALE 1:8	WEIGHT	SHEET 1/1



8 7 6 5 4 3 2 1

H  
G  
F  
E  
D  
C  
B  
A

H  
G  
F  
E  
D  
C  
B  
A

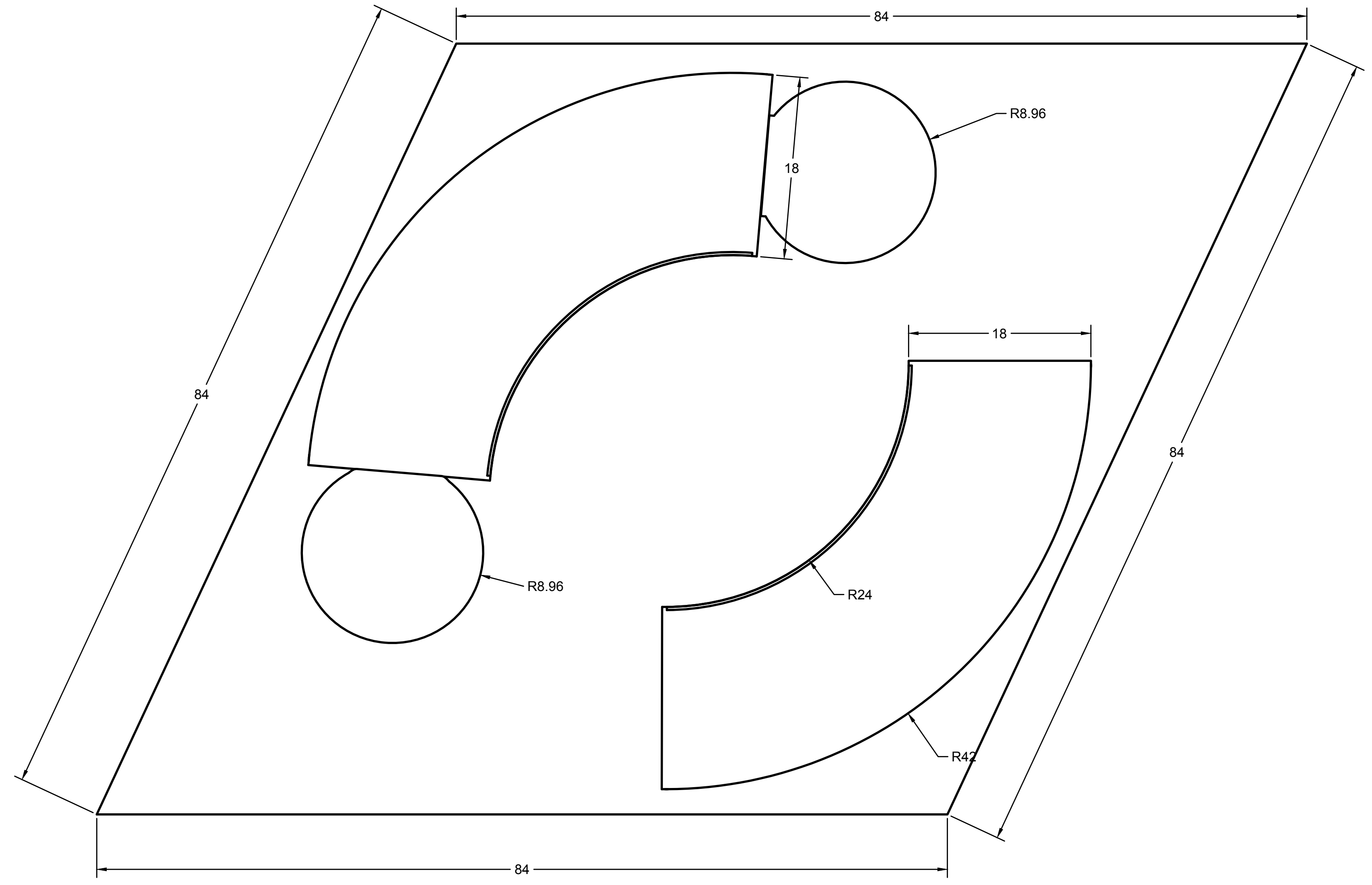
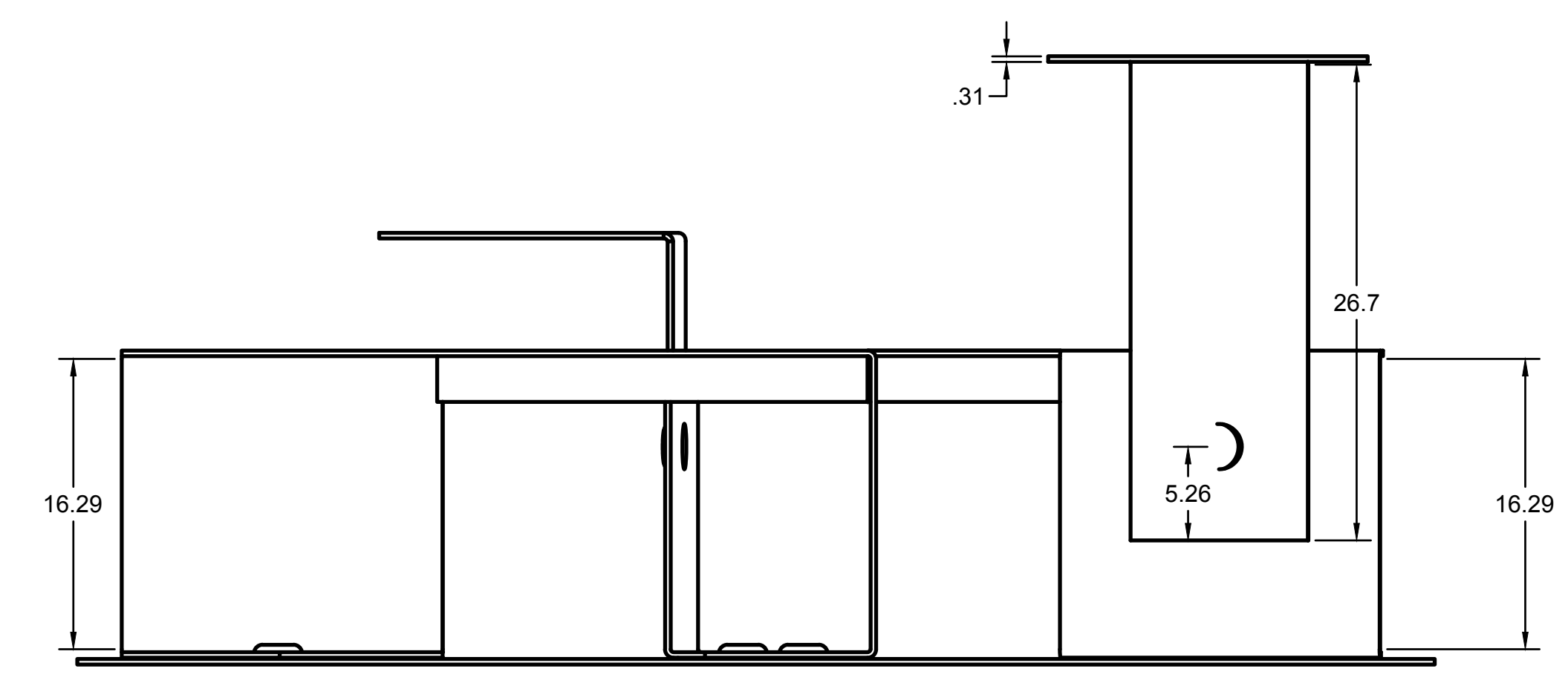
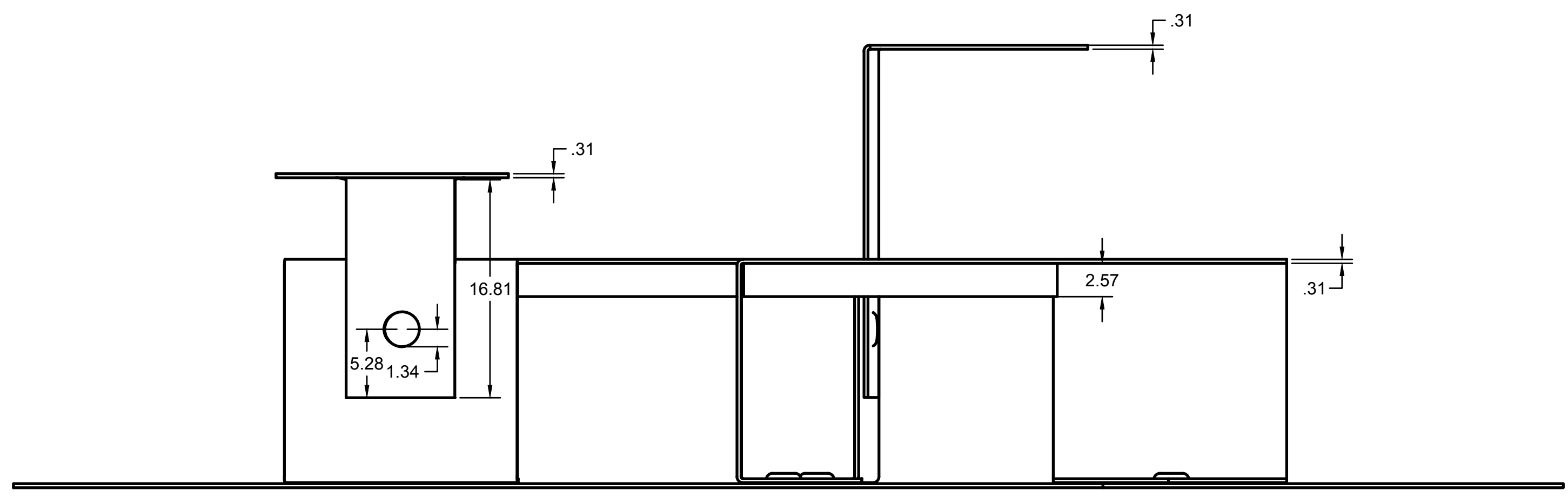

DIMENSION UNIT: IN		PROJECT Admin Project			
		TITLE puzzle sitting1			
APPROVED	SIZE	CODE	DWG NO	REV	
CHECKED	E				
DRAWN	xinyi ren	8/2021	SCALE 1:8	WEIGHT	SHEET 1/1

8 7 6 5 4 3 2 1



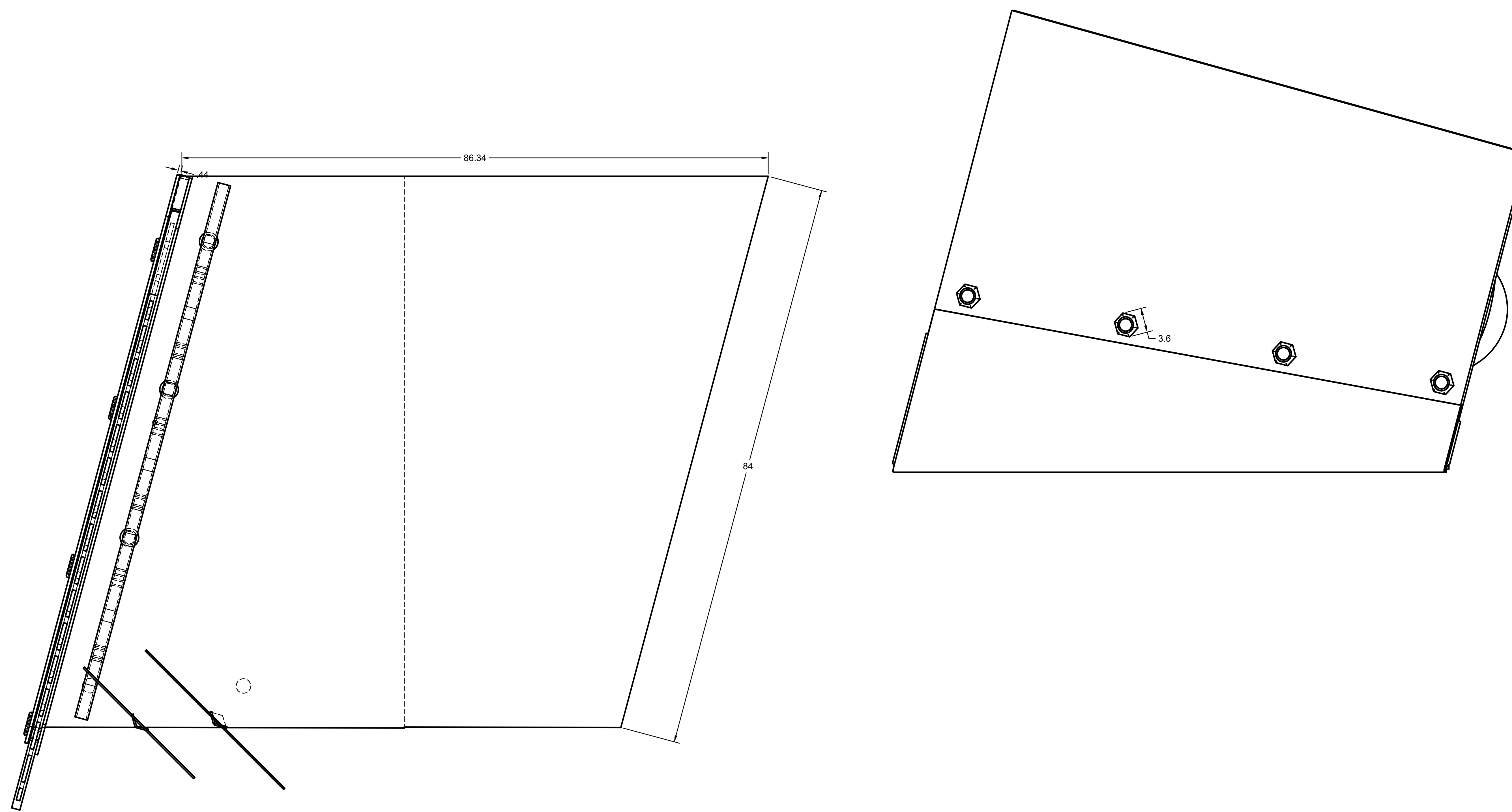
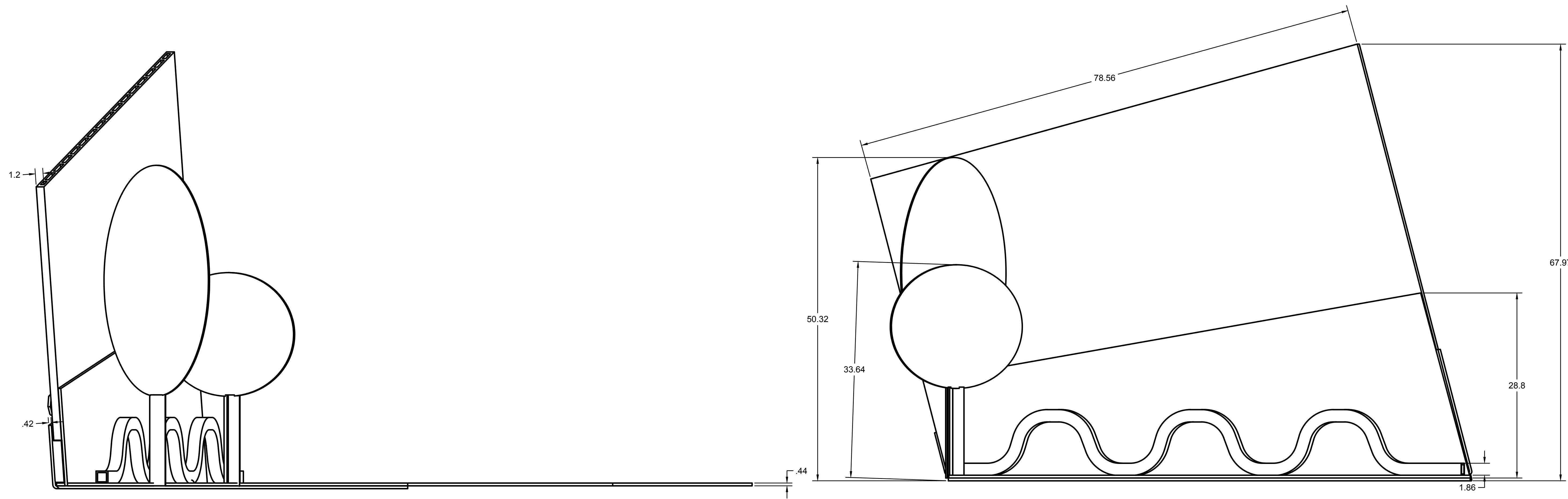

PROJECT		Admin Project		
TITLE		Public Activities		
DIMENSION UNIT: IN				
APPROVED	SIZE	CODE	DWG NO	REV
CHECKED	E			
DRAWN	xinyi.ren	8/20/21	SCALE 1:8	WEIGHT
				SHEET 1/1



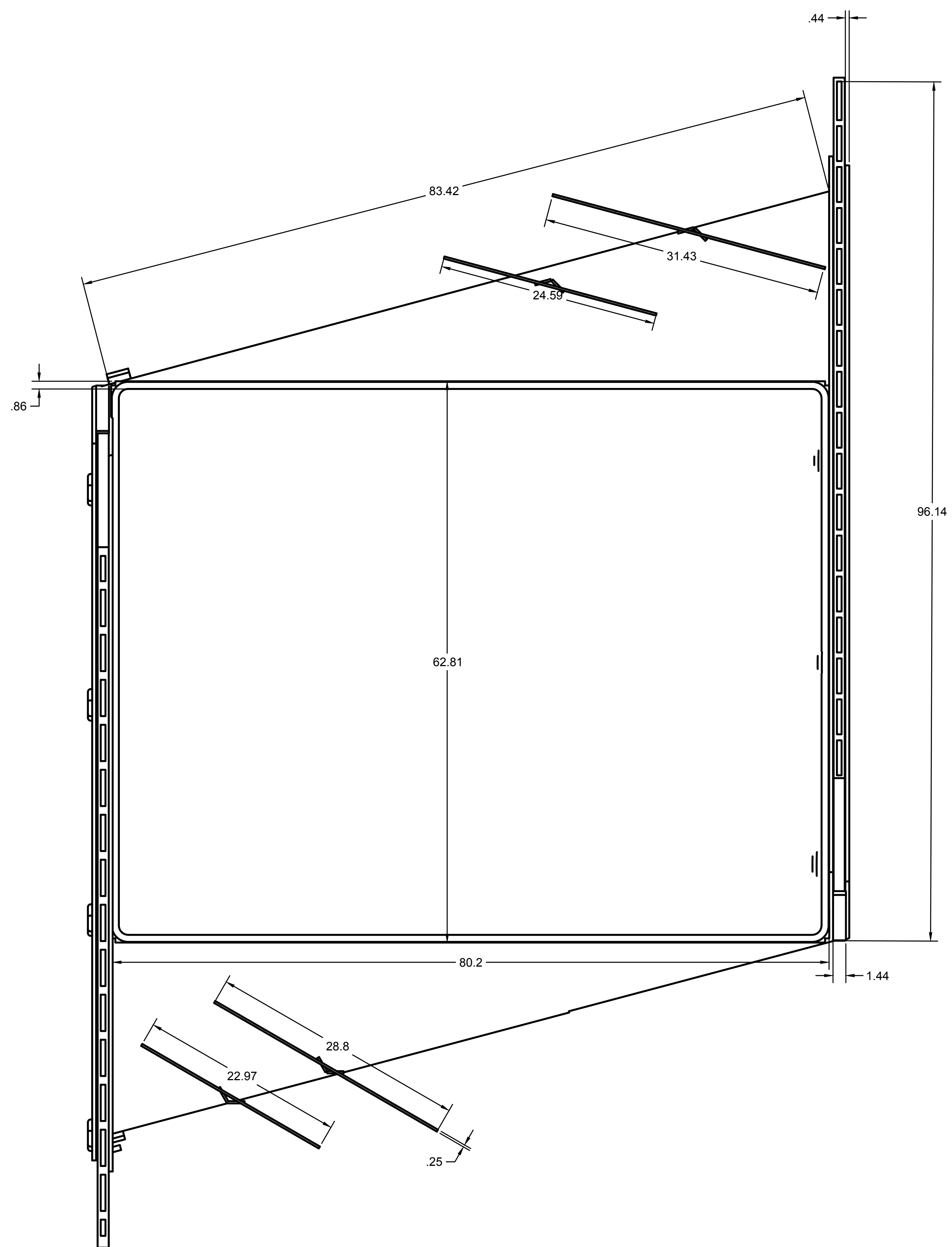
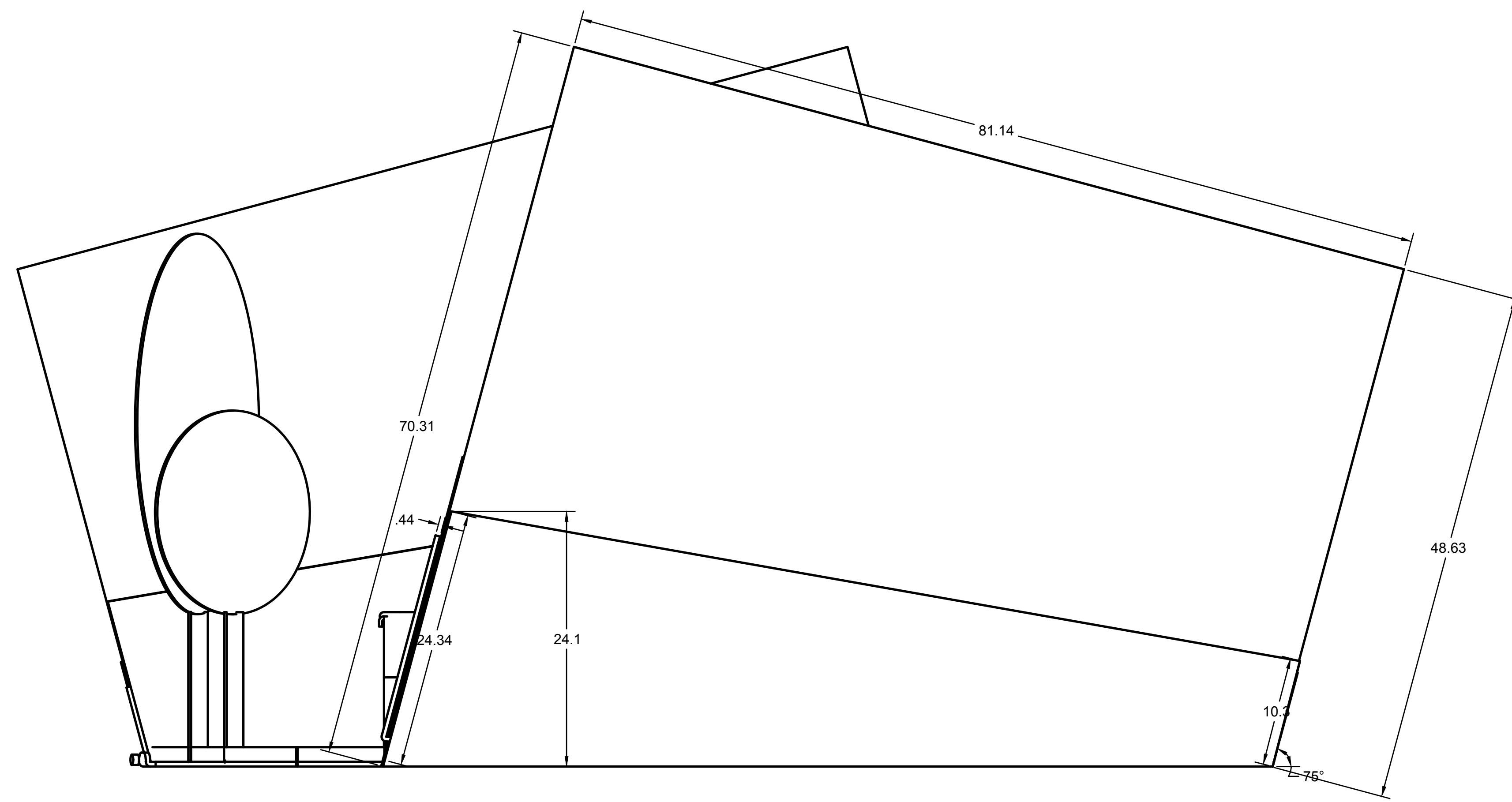
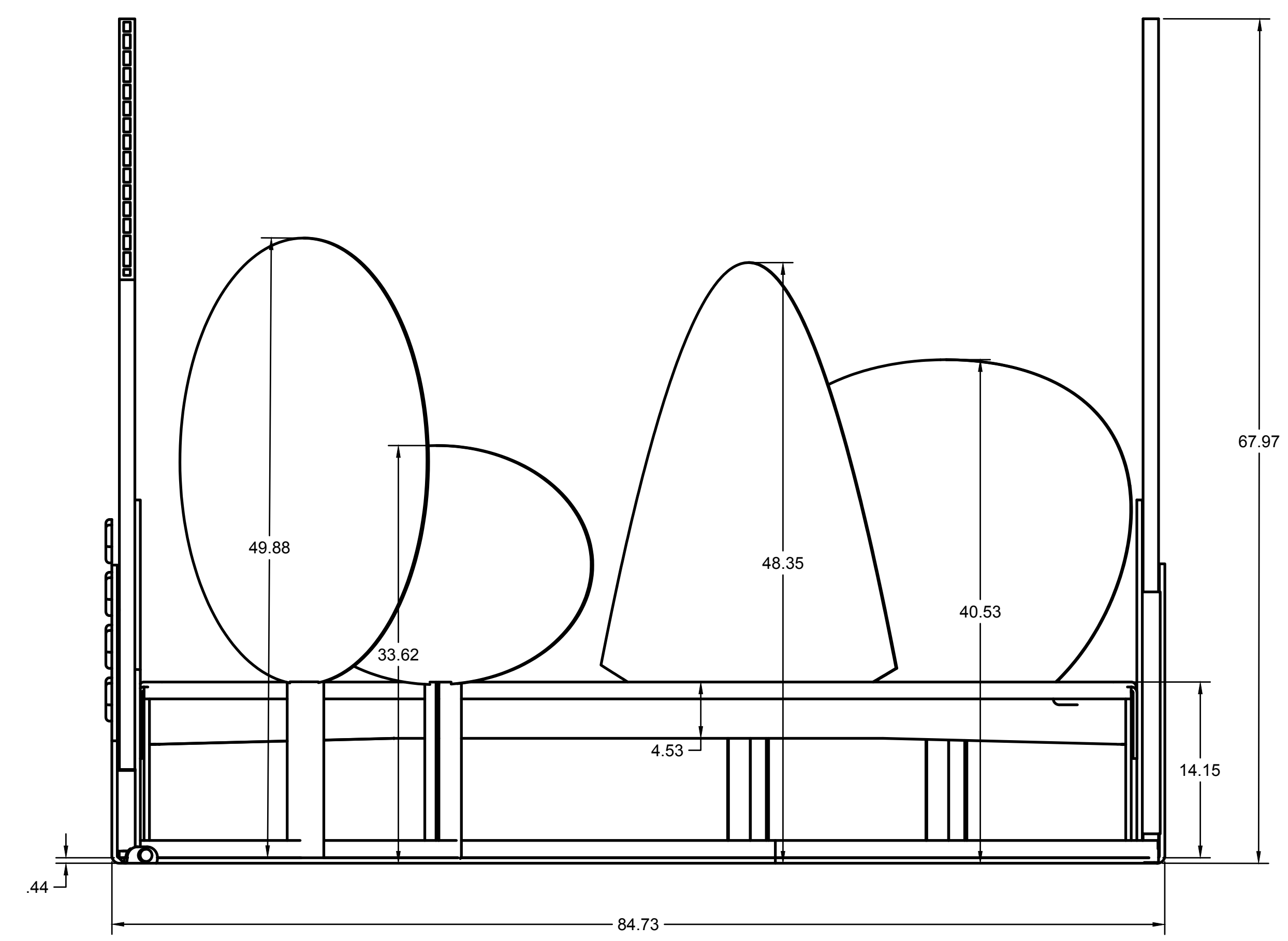

PROJECT		Admin Project		
TITLE		picnic module 1:1		
DIMENSION UNIT: IN				
APPROVED	SIZE	CODE	DWG NO	REV
CHECKED	E			
DRAWN	xinyi ren	8/2021	SCALE 1:8	WEIGHT
				SHEET 1/1



8 7 6 5 4 3 2 1

H  
G  
F  
E  
D  
C  
B  
A

H  
G  
F  
E  
D  
C  
B  
A

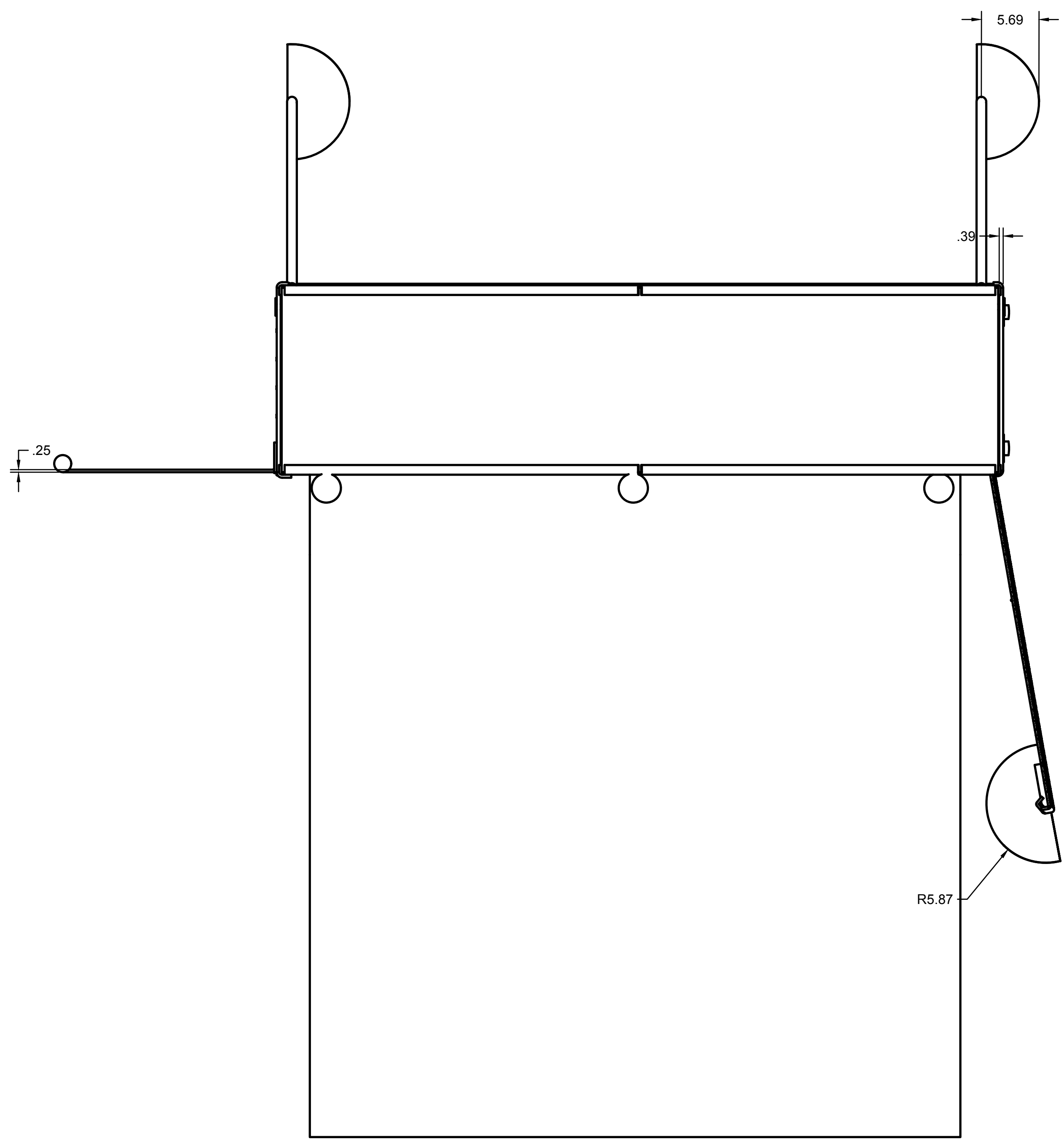
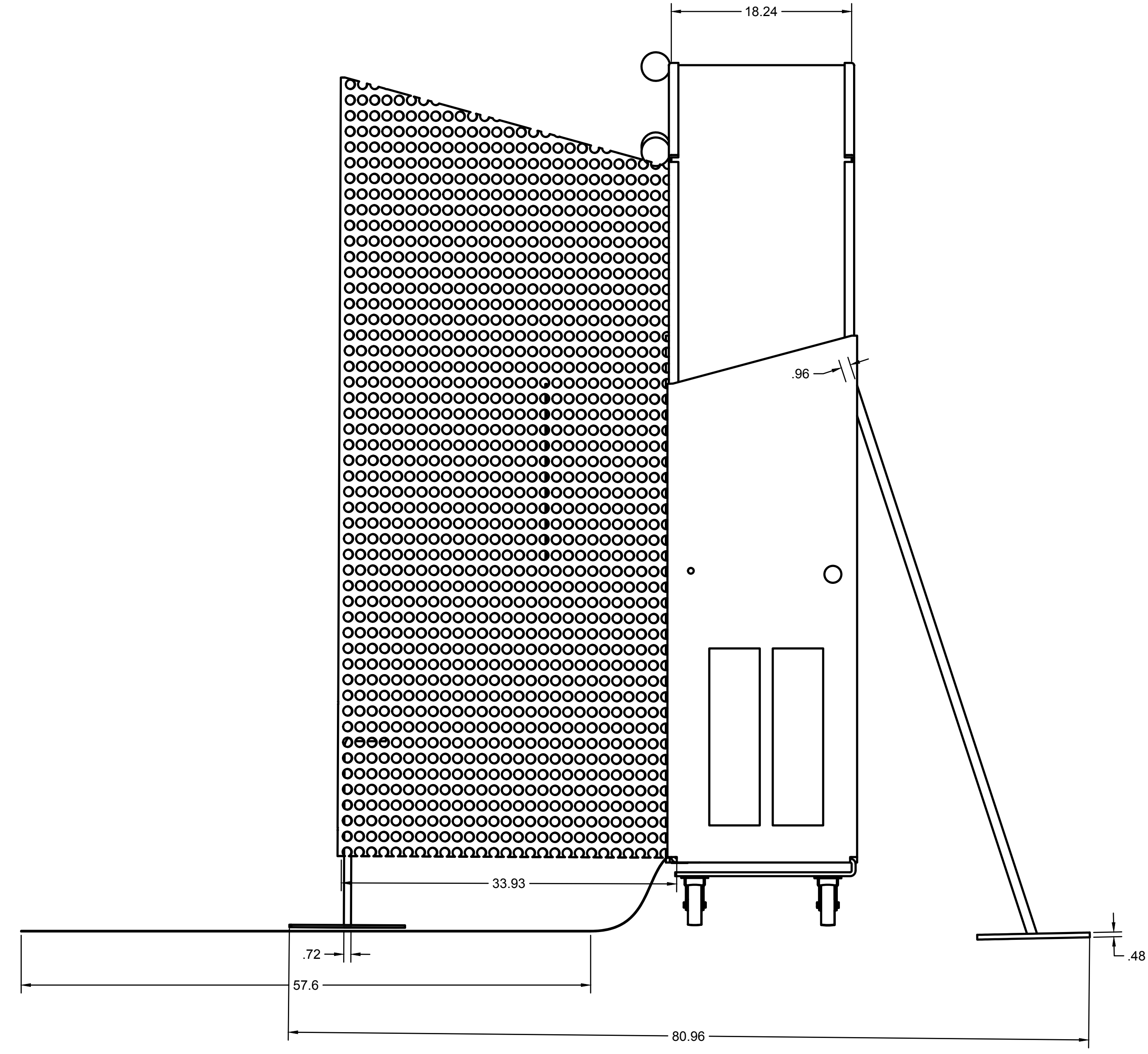
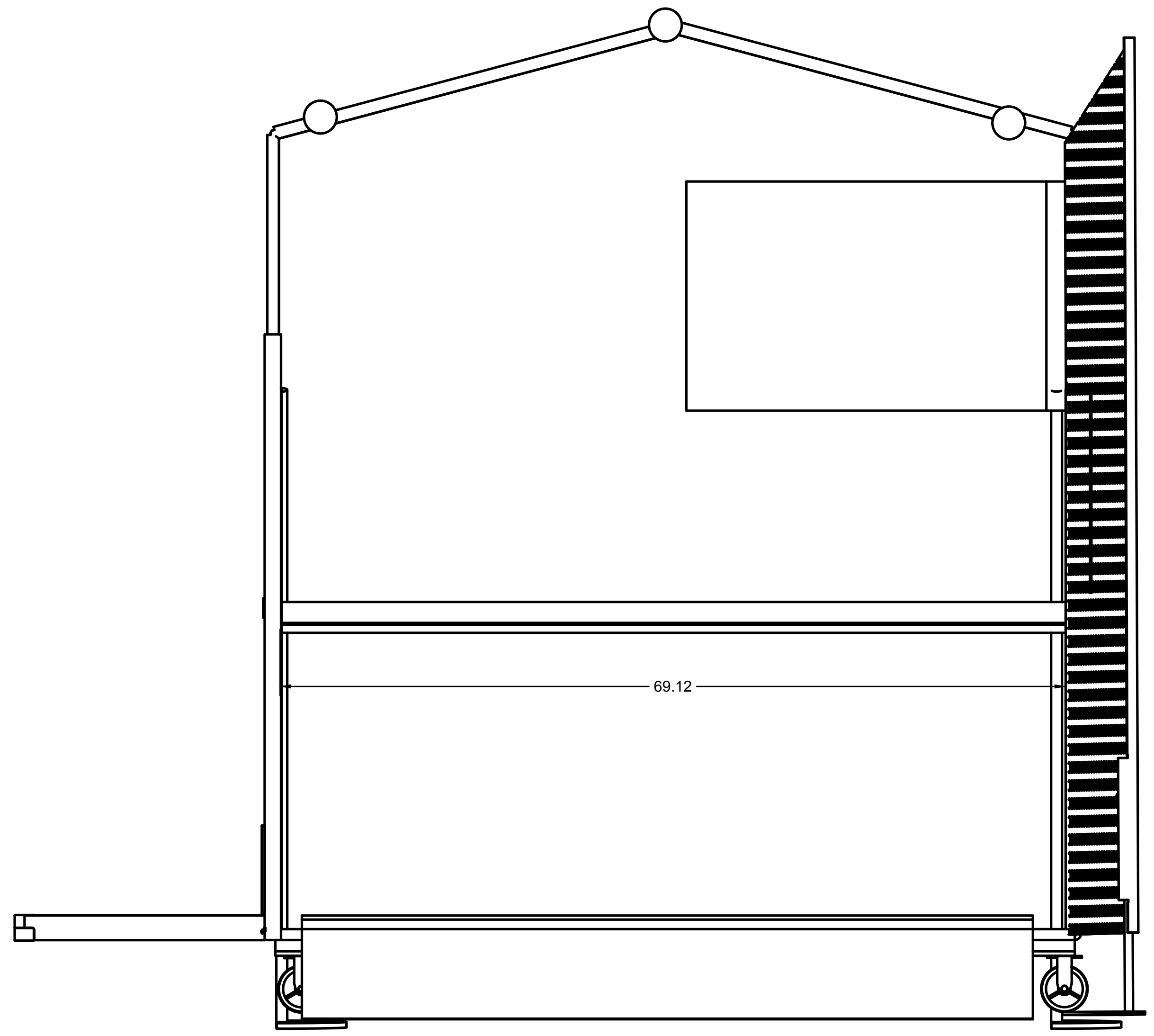

DIMENSION UNIT: IN		PROJECT Admin Project			
		TITLE MiniMarket			
APPROVED	SIZE	CODE	DWG NO	REV	
CHECKED	E				
DRAWN	xinyi ren	8/2021	SCALE 1:8	WEIGHT	SHEET 1/1

8 7 6 5 4 3 2 1